

ILS = Tradition and Technology

ILS is based in Stützerbach, a tiny village in the beautiful forest of Thuringia, in the heart of Germany. Though small in size, Stützerbach has made its name throughout the world and can claim to a long history in glassware.



Since the first glass company was founded in 1674 Stützerbach has been a place of innovation: the German thermometer (1830), the electric bulb (1883), the vacuum flask (1895) as well as the Röntgen X-ray tube (1893) were all first developed in Stützerbach.

ILS was founded in 1992 implementing the skills and expertise of the people in the area. More than 1,000 types and variations of microsyringes are manufactured here today. Syringes range from 1 µl to 100 ml for precision sampling and dosage in chromatography, spectroscopy, preparation of standard solutions, for manual application, and for use in autosamplers, diluters, dispensers and other liquid handling instruments. Precision diluter valves are also available as a recent addition to the production range.



ILS shrinks its own precision bore tubing from DURAN[®], a highly resistant borosilicate glass and all metal parts and PTFE-seals are made in-house. State of the art computer controlled equipment such as milling machines, lathes and glass shrinking equipment, together with years of glass working experience, guarantee the optimum quality of the products.

DURAN[®] is a registered trademark of SCHOTT Glaswerke AG

I.C.T, S.L. - INSTRUMENTACION CIENTIFICA TÉCNICA, S.L.

Avda. de Juan Carlos I, 24 · 26140 Lardero (La Rioja) · España

Tel: (+34) 902 193 170 · Fax: (+34) 902 193 167

Http://www.ictsl.net · E-mail: información@ictsl.net

Syringe Production

Precision Glass Work

ILS employs experienced and skilled craftsmen to produce high quality glassware.



Modern Glass Technology

Precesion machinery, mainly developed in-house, is used for the manufacturing of our syringes.

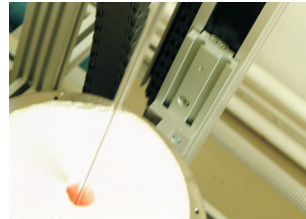

CNC - Metal and Plastic Machining

State of the art computer controlled machines as mills, turning machines, and high precision tools guarantee the high quality of seals, plungers, fittings etc.

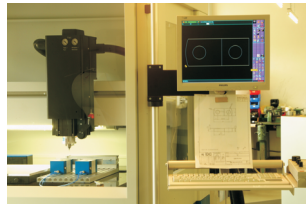

Careful Assembly

Thoroughly trained personnel add the final touch to our products.



Quality Control

Each product is meticulously checked before shipping.



Custom Made Products

You name it - we make it!

Contact us for special developments. We are allways ready to break new ground and develop new products.



Repair & Maintenance Service

We offer an extensive maintenance and repair service for microsyringes of all brands. To ensure a safe and quick repair, the syringes should be cleaned and decontaminated carefully before sending back to us.

Please ship, freight and duty prepaid, to:

ILS Innovative Laborsysteme GmbH
Repair Service
Mittelstrasse 37
98714 Stützerbach
Germany

Contents

ILS = Tradition and Technology	1
Syringe Production	2
Custom Made Products, Repair & Maintenance Service	3
Needle Tip Styles	6
Syringe Needles	
1. Removable Needles for ILS Syringes	7
2. NLL Needles with Metal Luer-Screw	8
3. KNLL Needles with Plastic Luer-Screw	9
Dosage of Liquids: Series N	
1. Fixed Needles	10
2. Fixed Needles, Customized Length, with Guide	11
3. Removable Needles	12
4. Removable Needles, Customized Length, with Guide	13
5. TLL PTFE-Luer-Lock	14
6. Super Elastic Plungers	15
Dosage of Liquids: Series SN	
1. With Extended Handle	16
2. With Extended Handle, Customized Length & Replacement Barrels	17
Dosage of Liquids: Series T	
1. Zero Dead Volume Syringes	18
2. Replacement Parts	19
Dosage of Gas and Liquids: Series H	
1. Fixed Needles	20
2. Fixed Needles, Customized Length	21
3. Removable Needles	22
4. Removable Needles, Customized Length	23
5. LT Glass-Luer-Tip without needle	24
6. TLT PTFE-Luer-Tip without needle	25
7. TLL PTFE-Luer-Lock	28
Dosage of Gas and Liquids: Series SH	
1. With Extended Handle	26
2. With Extended Handle, Customized Length & Replacement Barrels	27
Dosage of Gas and Liquids: Series G	
With Static PTFE-Seal Topping the Glass Barrel	29
Dosage of Gas and Liquids: Series P	
1. With Adjustable PTFE-Seal	30
2. With Adjustable PTFE-Seal, Customized Length	31

Contents

Syringes for Headspace Analysis	32
Syringes for On-Column Injection	33
Syringes for GC Autosamplers	
1. Dani ALS	34
2. Agilent Technologies (HP) 7670, 7671, 7672	35
3. Agilent Technologies (HP) 7673 – 7683	36
4. LEAP Technologies, CTC, Carlo Erba, Finsons	38
5. Shimadzu AOC	39
6. Perkin Elmer	40
Syringes for GC Headspace Sampling	
Thermo Quest ,Thermo Finnigan, CTC	41
HPLC-Syringes	
1. Most Common Valves	42
2. Waters Valves	43
3. Valco VSF-1 Valves	44
HPLC-Syringes for Autosampler	
1. Gynkotech Dionex Gina, Agilent (HP) 1090A, Hitachi	45
2. Waters, Spark, Kontron	46
3. Perkin Elmer	48
4. LEAP Technologies, CTC, Shimadzu	49
5. Thermo Finnigan, Thermo Separation, Varian	50
Syringes for TLC	
Camag Linomat III and IV	51
Syringes for Automatic Liquid Handling	
1. PTFE-Seals, Chemically Resistant Heavy Duty Syringes	52
2. Modified PTFE-Seals for Buffers	58
3. Special PE-Seals for Smoother Operation	64
4. ABI, Abbott, Selectra, H-I, Varian	70
Syringes for Robbins Hydra®	72
Syringes with PEEK-Tubing Connectors	74
Accessories for Connectors	75
Syringes with Adjustable Internal Stopper	76
Accessories	78
Syringe Guide, Syringe Rack, Cleaning Wires	79

Needle Tip Styles



a

Needle Tip "a"

This tip is designed for optimum penetration of the septa and prevents septa coring. The 17° bevel is the proven standard. In addition our electro tapered tip minimizes the necessary piercing force and diameter of the injection channel.



b

Needle Tip "b"

This tip has a 90° bevel for precise pipetting. This design releases drops completely, for maximum reproducibility. It is widely used for HPLC sample injection.



c

Needle Tip "c"

This tip has been specially designed for autosamplers in routine applications. The electro tapered tip and the polished 90° square end eliminate burrs. It is ideal for PTFE laminated seals and regular septas.



d

Needle Tip "d"

Tip "d" is equipped with a side opening for dispensing and filling. This design avoids plugging and minimizes septum damage. It is ideal for thicker septa, recommended for headspace analysis.

Syringe Needles

1. Removable Needles for ILS Syringes

O.D. mm	Length mm	Tip Style	Tapered	Volume Pack	Volume				
					5 µl	10 µl	25 µl - 100 µl	250 µl - 10.0 ml	
0.47	42	a	yes	3	2865308	2865408	-	-	
0.47	42	c	no	3	2834307	2834407	-	-	
0.47	51	a	yes	3	2832301	2832401	-	-	
0.47	51	b	no	3	2832302	2832402	-	-	
0.47	51	c	yes	3	2832303	2832403	-	-	
0.47	51	d	no	2	2832304	2832404	-	-	
0.55	51	a	yes	3	-	-	2831013	2841013	
0.55	51	b	no	3	-	-	2831014	2841014	
0.55	51	d	no	2	-	-	2831015	2841015	
0.64/0.47	42	c	yes	3	2834308	2834408	-	-	
0.64	42	c	no	3	2834309	2834409	-	-	
0.72	51	a	yes	3	-	-	2832501	2832601	
0.72	51	c	yes	3	-	-	2832503	2832603	
0.72	51	d	no	2	-	-	2832504	2832604	
0.90	51	a	no	3	-	-	-	2831023	
1.10	51	a	no	3	-	-	-	2831027	
2.00	51	a	no	2	-	-	-	2831029	
HP 7670 - 7672									
0.47	51	a	yes	3	2860307	2860407	-	-	
Waters									
0.50	50	b	no	3	2832306	2832406	2832506	2842606	
Valco VISF-1									
0.72	19	b	no	3	2833305	2833405	-	2833505	
Rheodyne									
0.72	51	b	no	3	2831305	2831405	2831505	2832602	
Removable needles for Hamilton syringes									
0.50	50	b	no	3	-	-	21080426	-	
0.47	51	a	yes	3	-	-	21775802	-	
0.72	51	a	yes	3	-	-	21777003	21777904	
0.72	51	b	no	3	-	-	21777001	21777901	

We can manufacture needles to your specifications.

Please ask for a quotation. Indicate length, diameter and type!

Syringe Needles

2. NLL Needles with Metal Luer-Screw

Length: 51 mm
 Needles: CrNi 1.4301 (AISI SS 304)
 Luer: Brass, Nickel plated



Gauge	O.D. (mm)	I.D. (mm)	Tip Style a 3 Pack	Tip Style b 3 Pack	Tip Style d 2 Pack
33	0.20	0.11	2840020	2842020	-
32	0.25	0.11	2840025	2842025	-
30	0.30	0.15	2840030	2842030	-
29	0.35	0.15	2840035	2842035	-
27	0.40	0.20	2840040	2842040	-
26	0.45	0.25	2840045	2842045	-
26s	0.47	0.13	2840047	2842047	-
25	0.50	0.28	2840050	2842050	2843050
24	0.55	0.32	2840055	2842055	2843055
23	0.65	0.35	2840065	2842065	2843065
22	0.72	0.41	2840070	2842070	2843070
22s	0.72	0.20	2840072	2842072	-
21	0.80	0.50	2840080	2842080	2843080
20	0.90	0.60	2840090	2842090	2843090
	1.00	0.68	2840100	2842100	2843100
19	1.10	0.80	2840110	2842110	2843110
18	1.30	0.90	2840130	2842130	2843130
17	1.50	1.10	2840150	2842150	2843150
16	1.70	1.20	2840170	2842170	2843170
15	1.80	1.40	2840180	2842180	2843180
	2.00	1.26	2840200	2842200	2843200
13	2.40	1.90	2840240	2842240	2843240
12	2.80	2.20	2840280	2842280	2843280
	3.00	2.06	2840302	2842302	2843302
11	3.00	2.40	2840304	2842304	2843304
10	3.40	2.70	2840340	2842340	2843340

We can manufacture needles to your specifications.
 Please ask for a quotation. Indicate length, diameter and type!

Syringe Needles

3. KNLL Needles with Plastic Luer-Screw

Length: 51 mm
 Needles: CrNi 1.4301 (AISI SS 304)
 Luer: Polyvinylidenfluorid (PVDF)



Gauge	O.D. (mm)	I.D. (mm)	Tip Style a 3 Pack	Tip Style b 3 Pack	Tip Style d 2 Pack
33	0.20	0.11	2846020	2849020	-
32	0.25	0.11	2846025	2849025	-
30	0.30	0.15	2846030	2849030	-
29	0.35	0.15	2846035	2849035	-
27	0.40	0.20	2846040	2849040	-
26	0.45	0.25	2846045	2849045	-
26s	0.47	0.13	2846047	2849047	-
25	0.50	0.28	2846050	2849050	2844050
24	0.55	0.32	2846055	2849055	2844055
23	0.65	0.35	2846065	2849065	2844065
22	0.72	0.41	2846070	2849070	2844070
22s	0.72	0.20	2846072	2849072	-
21	0.80	0.50	2846080	2849080	2844080
20	0.90	0.60	2846090	2849090	2844090
	1.00	0.68	2846100	2849100	2844100
19	1.10	0.80	2846110	2849110	2844110
18	1.30	0.90	2846130	2849130	2844130
17	1.50	1.10	2846150	2849150	2844150
16	1.70	1.20	2846170	2849170	2844170
15	1.80	1.40	2846180	2849180	2844180
	2.00	1.26	2846200	2849200	2844200
13	2.40	1.90	2846240	2849240	2844240
12	2.80	2.20	2846280	2849280	2844280
	3.00	2.06	2846302	2849302	2844302
11	3.00	2.40	2846304	2849304	2844304
10	3.40	2.70	2846340	2849340	2844340

We can manufacture needles to your specifications.
 Please ask for a quotation. Indicate length, diameter and type!

Dosage of Liquids: Series N

1. Fixed Needles

Plunger: Stainless steel
Glass Barrel: Borosilicate 3.3
Precision: < ±1% of the volume
Main Use: - sample dosage for gas chromatography
 - HPLC-valves
 - autosamplers



Volume	Needle Tip Style Length O.D.	fixed a 51 mm	fixed a 70 mm	fixed b 51 mm	fixed d 51mm
5 µl	0.47 mm	2100301	-	2100302	2100304
10 µl	0.47 mm	2100401	2100409	2100402	2100404
25 µl	0.72 mm	2100501	2100509	2100502	2100504
50 µl	0.72 mm	2100601	2100609	2100602	2100604
100 µl	0.72 mm	2100701	2100709	2100702	2100704
250 µl	0.72 mm	2100801	-	2100802	2100804
500 µl	0.72 mm	2100901	-	2100902	2100904

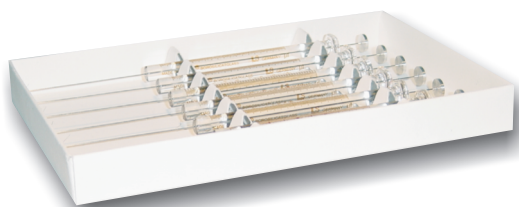

Six-Pack
 Economic pack of 6 syringes, fixed needles, length 51 mm tip style "a"

Volume	O.D.				
5 µl	0.47 mm	2100311	-	-	-
10 µl	0.47 mm	2100411	-	-	-

Dosage of Liquids: Series N

2. Fixed Needles, Customized Length, with Guide

Plunger: Stainless steel
Glass Barrel: Borosilicate 3.3
Precision: < ±1% of the volume
Main Use: - sample dosage for gas chromatography
 - HPLC-valves
 - autosamplers

Volume	Needle Tip Style Length O.D.	Special Length of Tip Style a or b or c	fixed Tip Style a 51 mm with Syringe Guide
5 µl	0.47 mm	2110300	2170301
10 µl	0.47 mm	2110400	2170401
25 µl	0.72 mm	2110500	2170501
50 µl	0.72 mm	2110600	2170601
100 µl	0.72 mm	2110700	2170701
250 µl	0.72 mm	2110800	2170801
500 µl	0.72 mm	2110900	2170901

Specify with Order
 1) Length in mm and
 2) Tip Style

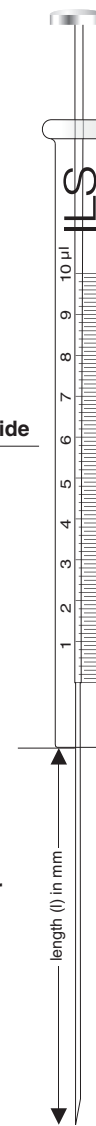
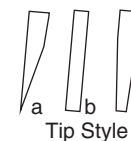

Dosage of Liquids: Series N

3. Removable Needles

Plunger: Stainless steel
Glass Barrel: Borosilicate 3.3
Precision: < ±1% of the volume
Main Use:

- sample dosage for gas chromatography
- HPLC-valves
- autosamplers

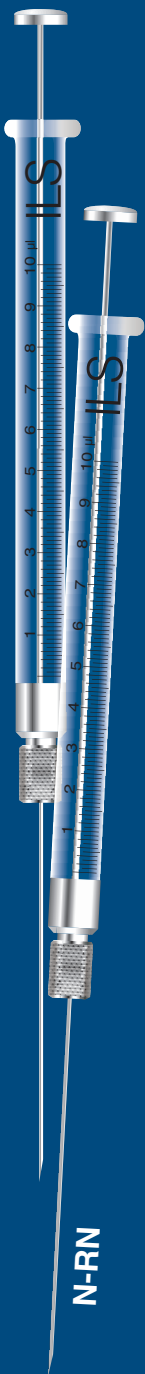

Volume	Needle Tip Style Length O.D.	removable a 51 mm	removable b 51 mm
5 µl	0.47 mm	2100305	2100306
10 µl	0.47 mm	2100405	2100406
25 µl	0.72 mm	2100505	2100506
50 µl	0.72 mm	2100605	2100606
100 µl	0.72 mm	2100705	2100706
250 µl	0.72 mm	2100805	2100806
500 µl	0.72 mm	2100905	2100906

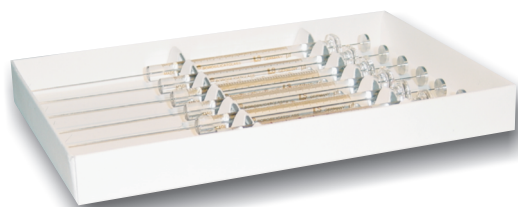

Six-Pack

Economic pack of 6 syringes, removable needles, length 51 mm tip style "a"

Volume	O.D.		
10 µl	0.47 mm	2100415	-

Dosage of Liquids: Series N

4. Removable Needles, Customized Length, with Guide

Plunger: Stainless steel
Glass Barrel: Borosilicate 3.3
Precision: < ±1% of the volume
Main Use:

- sample dosage for gas chromatography
- HPLC-valves
- autosamplers

Volume	Needle Tip Style Length O.D.	Special Length of Tip Style a or b or c	removable a 51 mm with Syringe Guide
5 µl	0.47 mm	2110301	2170305
10 µl	0.47 mm	2110401	2170405
25 µl	0.72 mm	2110501	2170505
50 µl	0.72 mm	2110601	2170605
100 µl	0.72 mm	2110701	2170705
250 µl	0.72 mm	2110801	2170805
500 µl	0.72 mm	2110901	2170905

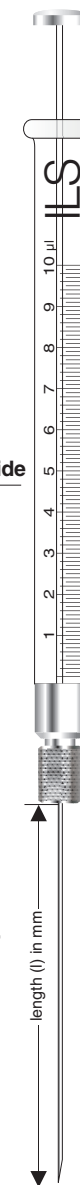

Specify with Order
 1) Length in mm
 and
 2) Tip Style

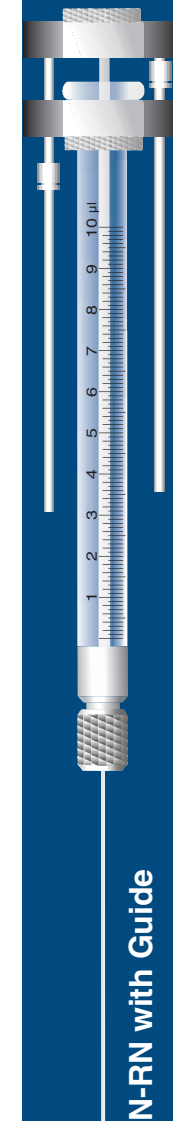
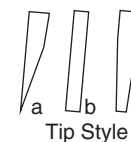

Dosage of Liquids: Series N

5. TLL PTFE-Luer-Lock

Plunger: Stainless steel
Glass Barrel: Borosilicate 3.3
Precision: < ±1% of the volume
Main Use: - sample dosage
 - dosage of aggressive liquids

Volume	
50 µl	2100611
100 µl	2100711
250 µl	2100811
500 µl	2100911

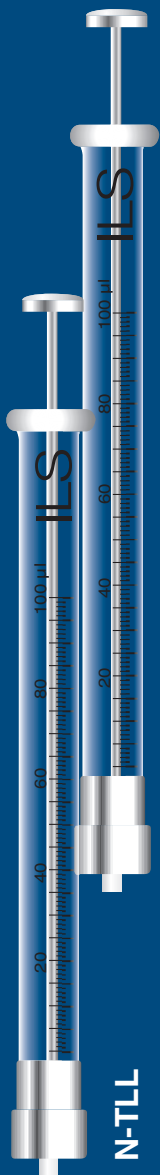

Dosage of Liquids: Series N

6. Super Elastic Plunger

Plunger: Nickel titanium alloy, flexible memory metal
Glass Barrel: Borosilicate 3.3
Precision: < ±1% of the volume
Main Use: - sample dosage for gas chromatography
 - HPLC-valves
 - autosamplers

Fixed Needles

Volume	Tip Style Length O.D.				
		a	b	c	d
5 µl	0.47 mm	2160301	2160302	2160303	2160304
10 µl	0.47 mm	2160401	2160402	2160403	2160404

Removable Needles

Volume	Tip Style Length O.D.				
		a	b	c	d
5 µl	0.47 mm	2160305	2160306	2160307	2160308
10 µl	0.47 mm	2160405	2160406	2160407	2160408

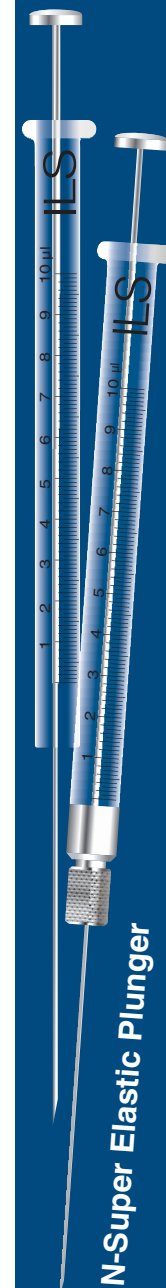

Dosage of Liquids: Series SN

1. With Extended Handle

- Plunger:** Stainless steel
Glass Barrel: Borosilicate 3.3
Precision: < ±1% of the volume
Handle:
 - protects the plunger from bending
 - prevents heat transfer from the hand to the contents of the syringe**Main Use:**
 - sample dosage for gas chromatography
 - HPLC-valves

Fixed Needles

Volume	Needle Tip Style Length O.D.	fixed a 51 mm	fixed b 51 mm
		5 µl	0.47 mm
10 µl	0.47 mm	2500401	2500402
25 µl	0.72 mm	2500501	2500502
50 µl	0.72 mm	2500601	2500602
100 µl	0.72 mm	2500701	2500702
250 µl	0.72 mm	2500801	2500802

Removable Needles

Volume	Needle Tip Style Length O.D.	removable a 51 mm	removable b 51 mm
		5 µl	0.47 mm
10 µl	0.47 mm	2500405	2500406
25 µl	0.72 mm	2500505	2500506
50 µl	0.72 mm	2500605	2500606
100 µl	0.72 mm	2500705	2500706
250 µl	0.72 mm	2500805	2500806

Dosage of Liquids: Series SN

2. With Extended Handle, Customized Length and Replacement Barrels

- Plunger:** Stainless steel
Glass Barrel: Borosilicate 3.3
Precision: < ±1% of the volume
Handle:
 - protects the plunger from bending
 - prevents heat transfer from the hand to the contents of the syringe**Main Use:**
 - sample dosage for gas chromatography
 - HPLC-valves

Fixed Needle, Special Length with Plunger

Volume	Needle Tip Style Length O.D.	Special Length of Tip Style a or b	Replacement Glass Barrel Tip Style a or b
			5 µl
10 µl	0.47 mm	2510400	2530401
25 µl	0.72 mm	2510500	2530501
50 µl	0.72 mm	2510600	2530601
100 µl	0.72 mm	2510700	2530701
250 µl	0.72 mm	2510800	2530801

Removable Needle, Special Length with Plunger

Volume	Needle Tip Style Length O.D.	Special Length of Tip Style a or b	Replacement Glass Barrel Tip Style a or b
			5 µl
10 µl	0.47 mm	2510405	2530405
25 µl	0.72 mm	2510505	2530505
50 µl	0.72 mm	2510605	2530605
100 µl	0.72 mm	2510705	2530705
250 µl	0.72 mm	2510805	2530805

Specify with Order
 1) Length in mm
 and
 2) Tip Style

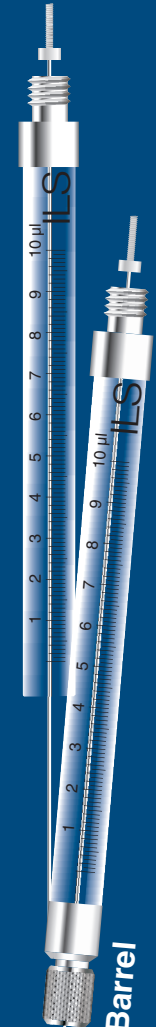
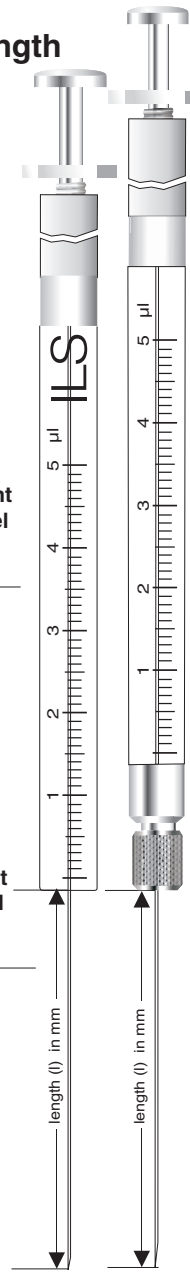
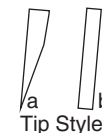

SN-Replacement Glass Barrel

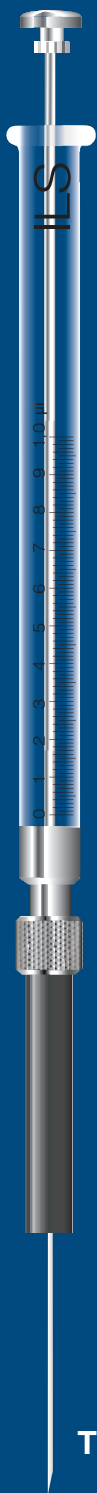

Dosage of Liquids: Series T

1. Zero Dead Volume Syringes

Plunger: Stainless steel, plunger runs inside the needle
Glass Barrel: Borosilicate 3.3
Precision: $\pm 1\%$ of the volume
Main Use: - sample dosage for gas chromatography
 - dosage of small amounts of liquids
 - for Thin Layer Chromatography (TLC)

Volume	Tip Style Length O.D.	a 70 mm	b 70 mm	d 70 mm
1 μ l	0.47 mm	2200101	2200102	2200103
5 μ l	0.55 mm	2200301	2200302	2200303

Volume	Tip Style Length O.D.	a 80 mm	b 80 mm	d 80 mm
2 μ l	0.72 mm	2200201	2200202	2200203
10 μ l	0.70 mm	2200401	2200402	2200403
25 μ l	1.10 mm	2200501	2200502	2200503

Dosage of Liquids: Series T

2. Replacement Parts

Plunger: Stainless steel, plunger runs inside the needle
Glass Barrel: Borosilicate 3.3
Precision: $\pm 1\%$ of the volume
Main Use: - sample dosage for gas chromatography
 - dosage of small amounts of liquids
 - for Thin Layer Chromatography (TLC)

Replacement Kit

Includes 1 needle and 1 calibrated plunger

Volume	Tip Style Length O.D.	a 70 mm Needle/ Plunger	a 80 mm Needle/ Plunger	b 70 mm Needle/ Plunger	b 80 mm Needle/ Plunger
1 μ l	0.47 mm	2231101	-	2231102	-
2 μ l	0.72 mm	-	2231201	-	2231202
5 μ l	0.55 mm	2231301	-	2231302	-
10 μ l	0.70 mm	-	2231401	-	2231402
25 μ l	1.10 mm	-	2231501	-	2231502

Sealing Kit

Includes 5 seals

Volume	O.D.	
1 μ l	0.47 mm	2230001
2 μ l	0.72 mm	2230002
5 μ l	0.55 mm	2230003
10 μ l	0.70 mm	2230004
25 μ l	1.10 mm	2230005

Dosage of Gas and Liquids: Series H

1. Fixed Needles

Plunger: Stainless steel with PTFE-seal
Glass Barrel: Borosilicate 3.3
Precision: < ±1% of the volume
Main Use:

- sample dosage for gas chromatography
- HPLC-valves
- autosamplers
- dosage of aggressive fluids

Volume	Needle Tip Style Length O.D.	fixed a 51 mm	fixed b 51 mm	fixed d 51 mm
5 µl	0.47 mm	2600301	2600302	2600304
10 µl	0.47 mm	2600401	2600402	2600404
25 µl	0.72 mm	2600501	2600502	2600504
50 µl	0.72 mm	2600601	2600602	2600604
100 µl	0.72 mm	2600701	2600702	2600704
250 µl	0.72 mm	2600801	2600802	2600804
500 µl	0.72 mm	2600901	2600902	2600904
1.0 ml	0.72 mm	2600000	2600001	2600002
2.5 ml	0.72 mm	2600020	2600021	2600022
5.0 ml	0.72 mm	2600040	2600041	2600042
10.0 ml	0.72 mm	2600060	2600061	2600062

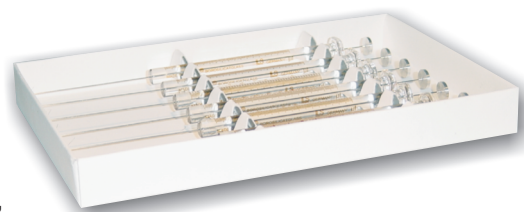

Six-Pack
 Economic pack of 6 syringes, fixed needles, length 51 mm tip style "a"

Volume	O.D.			
5 µl	0.47 mm	2600311	-	-
10 µl	0.47 mm	2600411	-	-

Dosage of Gas and Liquids: Series H

2. Fixed Needles, Customized Length

Plunger: Stainless steel with PTFE-seal
Glass Barrel: Borosilicate 3.3
Precision: < ±1% of the volume
Main Use:

- sample dosage for gas chromatography
- HPLC-valves
- autosamplers
- dosage of aggressive fluids

Volume	Needle Tip Style Length O.D.	Special Length of Tip Style a or b or c
5 µl	0.47 mm	2610300
10 µl	0.47 mm	2610400
25 µl	0.72 mm	2610500
50 µl	0.72 mm	2610600
100 µl	0.72 mm	2610700
250 µl	0.72 mm	2610800
500 µl	0.72 mm	2610900
1.0 ml	0.72 mm	2610000
2.5 ml	0.72 mm	2610020
5.0 ml	0.72 mm	2610040
10.0 ml	0.72 mm	2610060

Specify with Order
 1) Length in mm
 and
 2) Tip Style

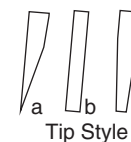

Dosage of Gas and Liquids: Series H

3. Removable Needles

Plunger: Stainless steel with PTFE-seal
 Glass Barrel: Borosilicate 3.3
 Precision: $\pm 1\%$ of the volume
 Main Use:

- sample dosage for gas chromatography
- HPLC-valves
- autosamplers
- dosage of aggressive fluids

Volume	Needle Tip Style Length O.D.	removable a 51 mm	removable b 51 mm	removable d 51 mm
5 μ l	0.47 mm	2600305	2600306	2600308
10 μ l	0.47 mm	2600405	2600406	2600408
25 μ l	0.72 mm	2600505	2600506	2600508
50 μ l	0.72 mm	2600605	2600606	2600608
100 μ l	0.72 mm	2600705	2600706	2600708
250 μ l	0.72 mm	2600805	2600806	2600808
500 μ l	0.72 mm	2600905	2600906	2600908
1.0 ml	0.72 mm	2600005	2600006	2600007
2.5 ml	0.72 mm	2600025	2600026	2600027
5.0 ml	0.72 mm	2600045	2600046	2600047
10.0 ml	0.72 mm	2600065	2600066	-

Dosage of Gas and Liquids: Series H

4. Removable Needles, Customized Length

Plunger: Stainless steel with PTFE-seal
 Glass Barrel: Borosilicate 3.3
 Precision: $\pm 1\%$ of the volume
 Main Use:

- sample dosage for gas chromatography
- HPLC-valves
- autosamplers
- dosage of aggressive fluids

Volume	Needle Tip Style Length O.D.	Special Length of Tip Style a or b
5 μ l	0.47 mm	2610309
10 μ l	0.47 mm	2610409
25 μ l	0.72 mm	2610509
50 μ l	0.72 mm	2610609
100 μ l	0.72 mm	2610709
250 μ l	0.72 mm	2610809
500 μ l	0.72 mm	2610909
1.0 ml	0.72 mm	2610007
2.5 ml	0.72 mm	2610027
5.0 ml	0.72 mm	2610047
10.0 ml	0.72 mm	2610067

Specify with Order
 1) Length in mm
 and
 2) Tip Style

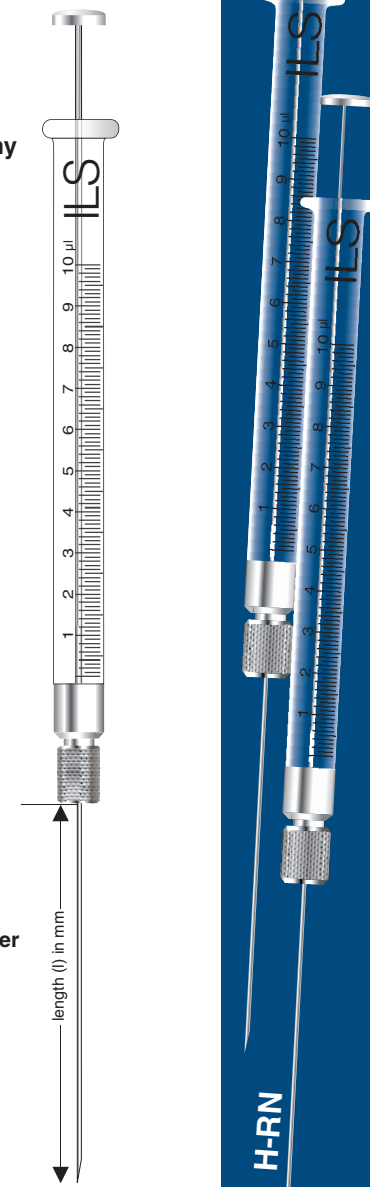
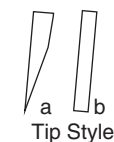

Dosage of Gas and Liquids: Series H

5. LT Glass-Luer-Tip without Needle

Plunger: Stainless steel with PTFE-seal
Glass Barrel: Borosilicate 3.3
Precision: < ±1% of the volume
Main Use:

- sample dosage
- dosage of aggressive fluids
- can be autoclaved

Volume	
5 µl	2600314
10 µl	2600412
25 µl	2600511
50 µl	2600611
100 µl	2600711
250 µl	2600811
500 µl	2600911
1.0 ml	2600013
2.5 ml	2600033
5.0 ml	2600053
10.0 ml	2600073



Dosage of Gas and Liquids: Series H

6. TLT PTFE-Luer-Tip without Needle

Plunger: Stainless steel with PTFE-seal
Glass Barrel: Borosilicate 3.3
Precision: < ±1% of the volume
Main Use:

- sample dosage
- dosage of aggressive liquids

Volume	
5 µl	2600313
10 µl	2600413
25 µl	2600513
50 µl	2600613
100 µl	2600713
250 µl	2600813
500 µl	2600913
1.0 ml	2600014
2.5 ml	2600034
5.0 ml	2600054
10.0 ml	2600074

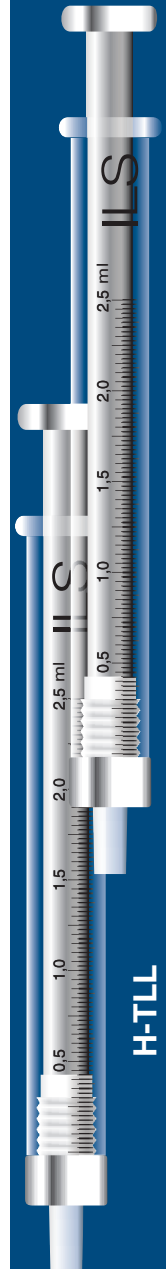

Dosage of Gas and Liquids: Series SH

1. With Extended Handle

- Plunger:** PTFE-seal
Glass Barrel: Borosilicate 3.3
Precision: < ±1% of the volume
Handle:
 - protects the plunger from bending
 - prevents heat transfer from the hand to the contents**Main Use:**
 - sample dosage for gas chromatography
 - HPLC-valves

Fixed Needle

Volume	Needle Tip Style Length O.D.	fixed a	fixed b
		51 mm	51 mm
5 µl	0.47 mm	2506301	2506302
10 µl	0.47 mm	2506401	2506402
25 µl	0.72 mm	2506501	2506502
50 µl	0.72 mm	2506601	2506602
100 µl	0.72 mm	2506701	2506702
250 µl	0.72 mm	2506801	2506802

Removable Needle

Volume	Needle Tip Style Length O.D.	a	b
		51 mm	51 mm
5 µl	0.47 mm	2506305	2506306
10 µl	0.47 mm	2506405	2506406
25 µl	0.72 mm	2506505	2506506
50 µl	0.72 mm	2506605	2506606
100 µl	0.72 mm	2506705	2506706
250 µl	0.72 mm	2506805	2506806

Dosage of Gas and Liquids: Series SH

2. With Extended Handle, Customized Length & Replacement Barrels

- Plunger:** PTFE-seal
Glass Barrel: Borosilicate 3.3
Precision: < ±1% of the volume
Handle:
 - protects the plunger from bending
 - prevents heat transfer from the hand to the contents of the syringe**Main Use:**
 - sample dosage for gas chromatography
 - HPLC-valves

Fixed Needle, Special Length with Plunger

Volume	Needle Tip Style Length O.D.	Special Length of Tip Style a or b	Replacement Glass Barrels Tip Style a or b
5 µl	0.47 mm	2516301	2536301
10 µl	0.47 mm	2516401	2536401
25 µl	0.72 mm	2516501	2536501
50 µl	0.72 mm	2516601	2536601
100 µl	0.72 mm	2516701	2536701
250 µl	0.72 mm	2516801	2536801

Removable Needle, Special Length with Plunger

Volume	Needle Tip Style Length O.D.	Special Length of Tip Style a or b	Replacement Glass Barrel Tip Style a or b
5 µl	0.47 mm	2516302	2536305
10 µl	0.47 mm	2516402	2536405
25 µl	0.72 mm	2516502	2536505
50 µl	0.72 mm	2516602	2536605
100 µl	0.72 mm	2516702	2536705
250 µl	0.72 mm	2516802	2536805

Specify with Order
 1) Length in mm
 and
 2) Tip Style

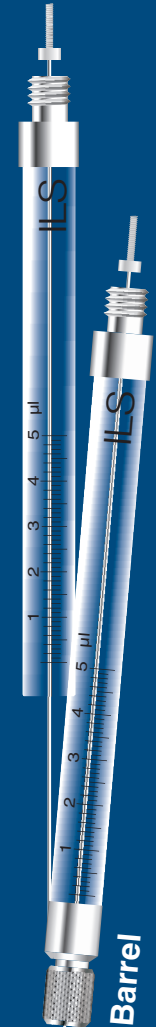
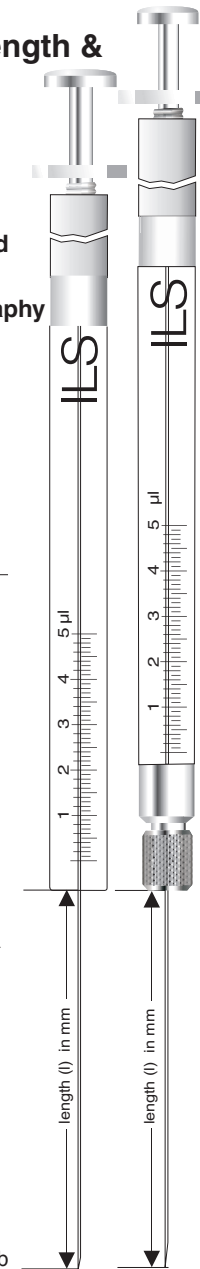
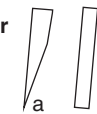

SH-Replacement Glass Barrel

Dosage of Gas and Liquids: Series H

7. TLL PTFE-Luer-Lock

Plunger: PTFE-seal
Glass Barrel: Borosilicate 3.3
Precision: < ±1% of the volume
Main Use: - sample dosage
 - dosage of aggressive liquids

Volume	
5 µl	2600309
10 µl	2600409
25 µl	2607509
50 µl	2607609
100 µl	2607709
250 µl	2607809
500 µl	2607909
1.0 ml	2607011
2.5 ml	2607031
5.0 ml	2607051
10.0 ml	2607071
25.0 ml	2607091
50.0 ml	2607101
100.0 ml	2607121

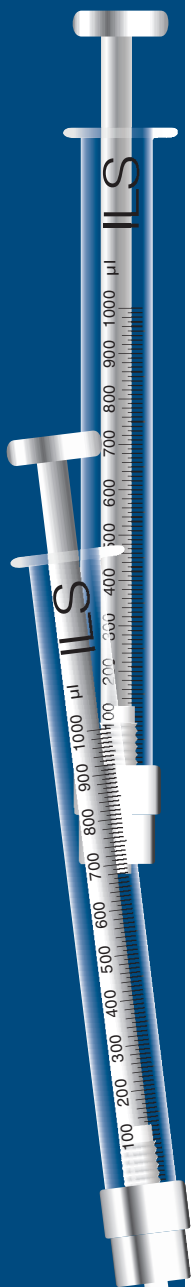

H-TLL

Dosage of Gas and Liquids: Series G

With Static PTFE-Seal Topping the Glass Barrel

Plunger: Stainless steel
Glass Barrel: Borosilicate 3.3
Precision: < ±1% of the volume
Seal: PTFE-seal at the end of glass barrel
Main Use: - sample dosage for gas chromatography
 - HPLC-valves
 - dosage with counter-pressure

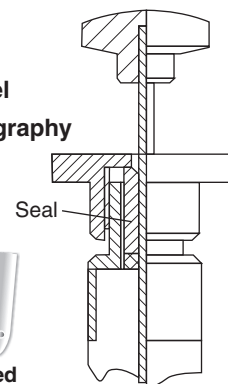

Fixed Needles

Volume	Needle Tip Style Length O.D.	fixed	fixed	fixed
		a	b	d
10 µl	0.47 mm	2400401	2400402	2400404
25 µl	0.72 mm	2400501	2400502	2400504
50 µl	0.72 mm	2400601	2400602	2400604
100 µl	0.72 mm	2400701	2400702	2400704
250 µl	0.72 mm	2400801	2400802	2400804
500 µl	0.72 mm	2400901	2400902	2400904

Removable Needles

Volume	Needle Tip Style Length O.D.	removable	removable	removable
		a	b	d
10 µl	0.47 mm	2400405	2400406	2400408
25 µl	0.72 mm	2400505	2400506	2400508
50 µl	0.72 mm	2400605	2400606	2400608
100 µl	0.72 mm	2400705	2400706	2400708
250 µl	0.72 mm	2400805	2400806	2400808
500 µl	0.72 mm	2400905	2400906	2400908



G

Dosage of Gas and Liquids: Series P

1. With Adjustable PTFE-seal

Plunger: Adjustable PTFE-seal on the plunger
 Glass Barrel: Borosilicate 3.3
 Precision: $\pm 1\%$ of the volume
 Main Use: - sample dosage for gas chromatography
 - HPLC-valves
 - dosage with counter-pressure

Fixed Needles

Volume	Tip Style Length O.D.	Tip Style			
		a	b	c	d
25 μ l	0.72 mm	2300501	2300502	2300503	2300504
50 μ l	0.72 mm	2300601	2300602	2300603	2300604
100 μ l	0.72 mm	2300701	2300702	2300703	2300704
250 μ l	0.72 mm	2300801	2300802	2300803	2300804
500 μ l	0.72 mm	2300901	2300902	2300903	2300904

Removable Needles

Volume	Tip Style Length O.D.	Tip Style			
		a	b	c	d
25 μ l	0.72 mm	2300505	2300506	2300507	2300508
50 μ l	0.72 mm	2300605	2300606	2300607	2300608
100 μ l	0.72 mm	2300705	2300706	2300707	2300708
250 μ l	0.72 mm	2300805	2300806	2300807	2300808
500 μ l	0.72 mm	2300905	2300906	2300907	2300908

Dosage of Gas and Liquids: Series P

2. With Adjustable PTFE-seal, Customized Length

Plunger: Adjustable PTFE-seal on the plunger
 Glass Barrel: Borosilicate 3.3
 Precision: $\pm 1\%$ of the volume
 Main Use: - sample dosage for gas chromatography
 - HPLC-valves
 - dosage under pressure

Fixed Needles

Volume	Needle Tip Style Length O.D.	Special Length Tip Style a or b or c
25 μ l	0.72 mm	2310500
50 μ l	0.72 mm	2310600
100 μ l	0.72 mm	2310700
250 μ l	0.72 mm	2310800
500 μ l	0.72 mm	2310900

Removable Needles

Volume	Needle Tip Style Length O.D.	Special needle Tip Style a or b or c
25 μ l	0.72 mm	2310501
50 μ l	0.72 mm	2310601
100 μ l	0.72 mm	2310701
250 μ l	0.72 mm	2310801
500 μ l	0.72 mm	2310901

Specify with Order

- Length in mm
- Tip Style

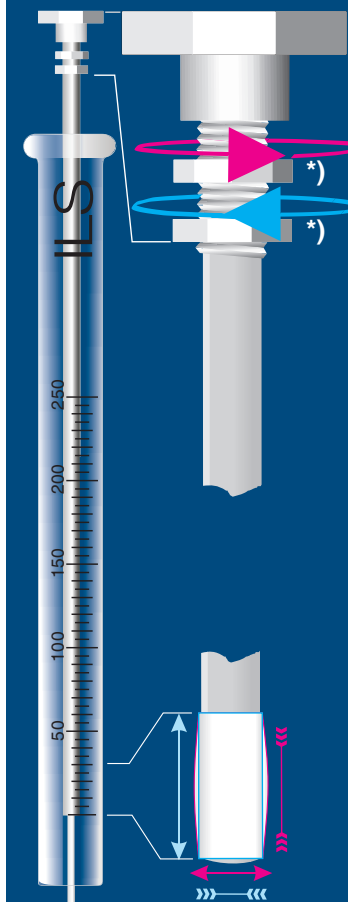
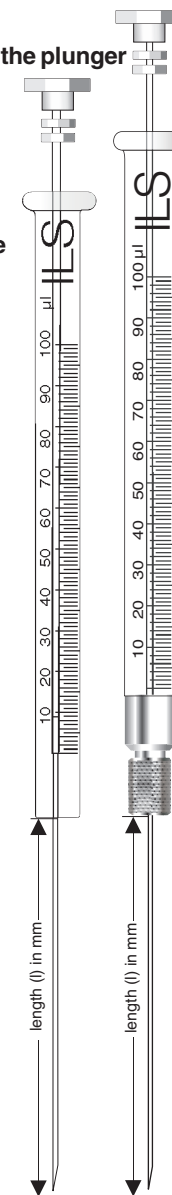
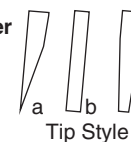

*) Clockwise turn of lower screw reduces pressure of PTFE-seal. Anti-clockwise turn of upper screw increases pressure of PTFE-seal.

Syringes for Headspace Analysis

Glass Barrel: Borosilicate 3.3
Precision: < ±1 % of the volume

Stainless steel with PTFE-seal

Volume	Tip Style Length O.D.	d 51 mm
1.0 ml	0.72 mm	2600002
2.5 ml	0.72 mm	2600022
5.0 ml	0.72 mm	2600042

Plunger with adjustable PTFE-seal

Volume	Tip Style Length O.D.	d 51 mm
50 µl	0.72 mm	2300604
100 µl	0.72 mm	2300704
250 µl	0.72 mm	2300804
500 µl	0.72 mm	2300904

Syringes for On-Column Injection

Glass Barrel: Borosilicate 3.3
Precision: < ±1% of the volume
Needles: Stainless steel (ss), fused silica

Fixed Needles

Volume	Material Tip Style Length O.D.	ss 45° 75 mm	ss 45° 85 mm
5 µl	0.23 mm	2142306	2142307

Special stainless steel plunger

5 µl	0.23 mm	2142306	2142307
------	---------	---------	---------

Removable Needles

Volume	Material Tip Style Length O.D.	ss 45° 75 mm	ss 45° 85 mm	ss 45° 100 mm	ss b 125 mm	fused silica b 100 mm
5 µl	0.17 mm	-	-	-	-	2142303
5 µl	0.23 mm	2142313	-	2142312	-	2142304
10 µl	0.17 mm	-	-	-	2142403	-
10 µl	0.23 mm	2142407	2142408	2142412	2142406	2142404

Special stainless steel plunger

5 µl	0.17 mm	-	-	-	-	2142303
5 µl	0.23 mm	2142313	-	2142312	-	2142304
10 µl	0.17 mm	-	-	-	2142403	-
10 µl	0.23 mm	2142407	2142408	2142412	2142406	2142404

With PTFE-plunger tip

10 µl	0.17 mm	-	-	-	-	2642401
10 µl	0.23 mm	-	-	-	-	2642402

Replacement Needles

Volume	Material Tip Style Length O.D.	ss 45° 85 mm 3 Pack	ss 45° 75 mm 3 Pack	ss 45° 100 mm 3 Pack	ss b 125 mm 3 Pack	fused silica b 100 mm 3 Pack
5 µl	0.17 mm	-	-	-	-	2822021
5 µl	0.23 mm	2822304	2822303	2822302	-	-
10 µl	0.17 mm	-	-	-	-	2822022
10 µl	0.23 mm	2822409	-	-	2822406	2822042

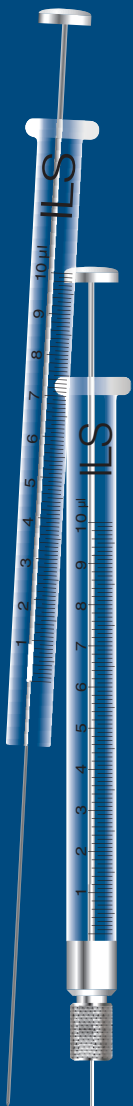

Dani

Syringes for GC Autosampler

1. Dani ALS

Glass Barrel: Borosilicate 3.3
Precision: $\pm 1\%$ of the volume

ALS 104	Needle Tip Style Length O.D.	fixed d	removable d
		51 mm	51 mm
Volume			
Special stainless steel with PTFE-seal			
10 μ l	0.63 mm	2607404	2607408
Special stainless steel plunger			
10 μ l	0.63 mm	2107404	2107408
			
ALS 3841	Needle Tip Style Length O.D.	fixed d	
Volume		51 mm	
Special stainless steel plunger			
10 μ l	0.63 mm	2107404	-

Syringes for GC Autosampler

2. Agilent Technologies (HP) 7670/7671/7672

Glass Barrel: Borosilicate 3.3
Precision: $\pm 1\%$ of the volume

ALS 104	Needle Tip Style Length O.D.	fixed a	removable a
		51 mm	51 mm
Volume			
Flexible plunger			
5 μ l	0.47 mm	2160301	2160305
10 μ l	0.47 mm	2160401	2160405
Special stainless steel plunger			
5 μ l	0.47 mm	2100301	2100305
10 μ l	0.47 mm	2100401	2100405
Special stainless steel plunger with PTFE-seal			
10 μ l	0.47 mm	2600401	2600405

Six-Pack

Economic pack of 6 syringes, fixed needles, length 51 mm tip style "a"

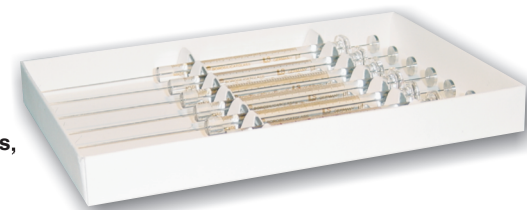

Volume	O.D.		
Special stainless steel plunger			
10 μ l	0.47 mm	2100411	-

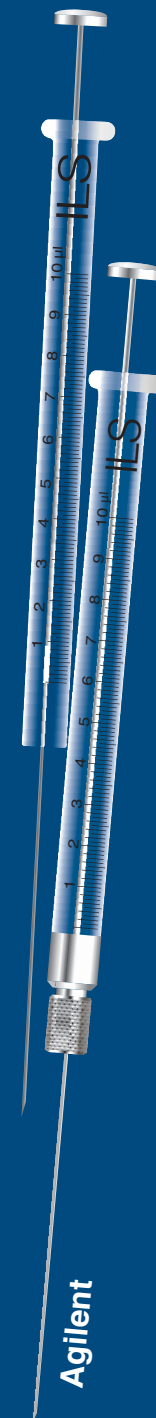

Agilent

Syringes for GC Autosampler

3. Agilent Technologies (HP) 7673 - 7683

Glass Barrel: Borosilicate 3.3
Precision: $\pm 1\%$ of the volume

Fixed Needles

Volume	Tip Style Length O.D.	42 mm		42 mm		42 mm		
		c	c	c	c	c	c	
		Six-Pack*		Six-Pack*		Six-Pack*		
Flexible plunger								
5 μ l	0.47 mm	2164303	2164313	-	-	-	-	
10 μ l	0.47 mm	2164403	2164413	-	-	-	-	
5 μ l	0.47/0.64 mm	-	-	2164304	2164314	-	-	
10 μ l	0.47/0.64 mm	-	-	2164404	2164414	-	-	
5 μ l	0.64 mm	-	-	-	-	2164305	2164315	
10 μ l	0.64 mm	-	-	-	-	2164405	2164415	
Special stainless steel plunger								
5 μ l	0.47 mm	2104303	2104313	-	-	-	-	
10 μ l	0.47 mm	2104403	2104413	-	-	-	-	
5 μ l	0.47/0.64 mm	-	-	2104304	2104314	-	-	
10 μ l	0.47/0.64 mm	-	-	2104404	2104414	-	-	
5 μ l	0.64 mm	-	-	-	-	2104305	2104315	
10 μ l	0.64 mm	-	-	-	-	2104405	2104415	
Special stainless steel plunger with PTFE-seal								
5 μ l	0.47 mm	2604303	2604313	-	-	-	-	
10 μ l	0.47 mm	2604403	2604413	-	-	-	-	
5 μ l	0.47/0.64 mm	-	-	2604304	2604314	-	-	
10 μ l	0.47/0.64 mm	-	-	2604404	2604414	-	-	
5 μ l	0.64 mm	-	-	-	-	2604305	2604315	
10 μ l	0.64 mm	-	-	-	-	2604405	2604415	

*Six-Pack

Economic pack of 6 syringes

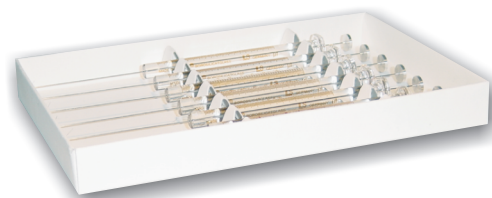

Syringes for GC Autosampler

3. Agilent Technologies (HP) 7673 - 7683

Glass Barrel: Borosilicate 3.3
Precision: $\pm 1\%$ of the volume

Removable Needles

Volume	Tip Style Length O.D.	42 mm		42 mm	
		c	c	c	c
Flexible plunger					
5 μ l	0.47 mm	2164307	-	-	-
10 μ l	0.47 mm	2164407	-	-	-
5 μ l	0.47/0.64 mm	-	2164308	-	-
10 μ l	0.47/0.64 mm	-	2164408	-	-
5 μ l	0.64 mm	-	-	2164309	-
10 μ l	0.64 mm	-	-	2164409	-
Special stainless steel plunger					
5 μ l	0.47 mm	2104307	-	-	-
10 μ l	0.47 mm	2104407	-	-	-
5 μ l	0.47/0.64 mm	-	2104308	-	-
10 μ l	0.47/0.64 mm	-	2104408	-	-
5 μ l	0.64 mm	-	-	2104309	-
10 μ l	0.64 mm	-	-	2104409	-
Special stainless steel plunger with PTFE-seal					
5 μ l	0.47 mm	2604307	-	-	-
10 μ l	0.47 mm	2604407	-	-	-
5 μ l	0.47/0.64 mm	-	2604308	-	-
10 μ l	0.47/0.64 mm	-	2604408	-	-
5 μ l	0.64 mm	-	-	2604309	-
10 μ l	0.64 mm	-	-	2604409	-

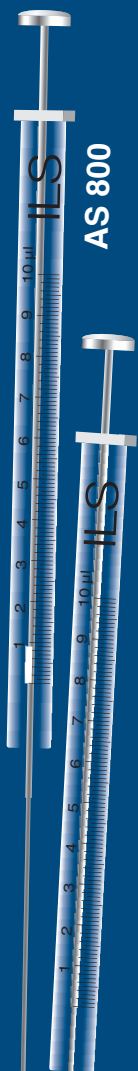

Syringes for GC Autosampler

4. LEAP Technologies, CTC, Carlo, Erba, Finsons

Glass Barrel: Borosilicate 3.3
Precision : $\pm 1\%$ of the volume

CTC A200 S
A200 SE
A800



Volume	Needle Tip Style Length O.D.	fixed a 51 mm	fixed c 51 mm	fixed c 70 mm	fixed c 80 mm	removable c 80 mm
Flexible plunger						
5 µl	0.47 mm	2166301	-	-	-	-
10 µl	0.47 mm	2166401	-	-	-	-
Special stainless steel plunger						
5 µl	0.47 mm	2106301	2106302	2108302	-	-
10 µl	0.47 mm	2106401	2106416	-	2106412	-
10 µl	0.72 mm	-	-	-	2106415	2106406
Special stainless steel plunger with PTFE-seal						
10 µl	0.47 mm	2606401	2606407	-	-	-
25 µl	0.47 mm	-	2620506	-	-	-
50 µl	0.47 mm	-	2620606	-	-	-
100 µl	0.47 mm	-	2620706	-	-	-
250 µl	0.47 mm	-	2620803	-	-	-
500 µl	0.47 mm	-	2620903	-	-	-

Six-Pack

Economic pack of 6 syringes, fixed needles, length 51 mm, tip style "a"

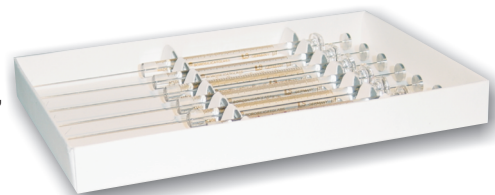

Volume	O.D.				
Special stainless steel plunger					
10 µl	0.47 mm	2106411	-	-	-

Syringes for GC Autosampler

5. Shimadzu AOC 14/17/20

Glass Barrel: Borosilicate 3.3
Precision : $\pm 1\%$ of the volume

AOC 14/17/20



Volume	Needle Tip Style Length O.D.	fixed a 42 mm	fixed c 42 mm	removable a 42 mm
Flexible plunger				
5 µl	0.47 mm	2165301	-	2165307
10 µl	0.47 mm	2165401	-	2165407
5 µl	0.63 mm	2165302	-	2165308
10 µl	0.63 mm	2165402	-	2165408
Special stainless steel plunger				
5 µl	0.47 mm	2105301	2105303	2105307
10 µl	0.47 mm	2105401	2105403	2105407
5 µl	0.63 mm	2105302	2105304	2105308
10 µl	0.63 mm	2105402	2105404	2105408
Special stainless steel plunger with PTFE-seal				
10 µl	0.47 mm	2605401	-	2605407
10 µl	0.63 mm	2605402	-	2605408

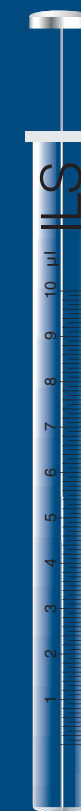

Syringes for GC Autosampler

6. Perkin Elmer

Glass Barrel: Borosilicate 3.3
Precision: $\pm 1\%$ of the volume

AS 100/AS 2000, AS 3000 GC Autosystems



Volume	Needle Tip Style Length O.D.	fixed c 70 mm
Special stainless steel plunger		
5 μ l	0.47 mm	2108302
5 μ l	0.63 mm	2108303
Special stainless steel plunger with PTFE-seal		
5 μ l	0.47 mm	2608302
5 μ l	0.63 mm	2608303

Syringes for GC Headspace Sampling

ThermoQuest, Thermo Finnigan, CTC

Glass Barrel: Borosilicate 3.3
Precision: $\pm 1\%$ of the volume

HS 500



Volume	Needle Tip Style Length O.D.	fixed d 56 mm	without
Special stainless steel plunger with PTFE-seal			
1.0 ml	0.47 mm	2620014	-
2.5 ml	0.47 mm	2620034	-
5.0 ml	0.47 mm	2620051	-
1.0 ml	0.64 mm	2620012	-
2.5 ml	0.64 mm	2620032	-
5.0 ml	0.64 mm	2620050	-
1.0 ml	0.72 mm	2620013	-
2.5 ml	0.72 mm	2620023	2620028
5.0 ml	0.72 mm	2620049	-

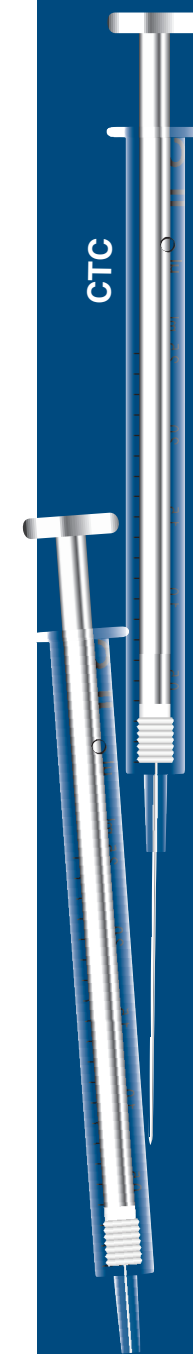

HPLC Syringes

1. Most Common Valves

Rheodyne, Varian, Shimadzu, Knauer, Hewlett Packard/
Agilent, Beckmann, Valco VISF-2 and Altex valve injectors

Glass Barrel: Borosilicate 3.3
Precision: $\lt; \pm 1\% \text{ of the volume}$

Volume	Needle Tip Style Length O.D.	fixed b 51 mm	removable b 51 mm	TLL Luer Lock
Flexible plunger				
5 μl	0.72 mm	2161302	2161306	-
10 μl	0.72 mm	2161402	2161406	-
Special stainless steel plunger				
5 μl	0.72 mm	2101302	2101306	-
10 μl	0.72 mm	2101402	2101406	-
25 μl	0.72 mm	2101502	2101506	-
50 μl	0.72 mm	2101602	2101606	2101609
100 μl	0.72 mm	2101702	2101706	2101709
250 μl	0.72 mm	2101802	2101806	2101809
500 μl	0.72 mm	2101902	2101906	2101909
Special stainless steel plunger with PTFE-seal				
5 μl	0.72 mm	2601302	2601306	-
10 μl	0.72 mm	2601402	2601406	-
25 μl	0.72 mm	2601502	2601506	-
50 μl	0.72 mm	2601602	2601606	2601609
100 μl	0.72 mm	2601702	2601706	2601709
250 μl	0.72 mm	2601802	2601806	2601809
500 μl	0.72 mm	2601902	2601906	2601909
1.0 ml	0.72 mm	2601001	2601002	2601003

HPLC Syringes

2. Waters Valves

Glass Barrel: Borosilicate 3.3
Precision: $\lt; \pm 1\% \text{ of the volume}$

Volume	Needle Tip Style Length O.D.	fixed b 50 mm	removable b 50 mm	TLL Luer Lock
Flexible plunger				
5 μl	0.50 mm	2162302	2162306	-
10 μl	0.50 mm	2162402	2162406	-
Special stainless steel plunger				
5 μl	0.50 mm	2102302	2102306	-
10 μl	0.50 mm	2102402	2102406	-
25 μl	0.50 mm	2102502	2102506	-
50 μl	0.50 mm	2102602	2102606	2102609
100 μl	0.50 mm	2102702	2102706	2102709
250 μl	0.50 mm	2102802	2102806	2102809
500 μl	0.50 mm	2102902	2102906	2102909
Special stainless steel plunger with PTFE-seal				
10 μl	0.50 mm	2602402	2602406	-
25 μl	0.50 mm	2602502	2602506	-
50 μl	0.50 mm	2602602	2602606	2602609
100 μl	0.50 mm	2602702	2602706	2602709
250 μl	0.50 mm	2602802	2602806	2602809
500 μl	0.50 mm	2602902	2602906	2602909
1.0 ml	0.50 mm	2602006	2602007	2602003
2.5 ml	0.50 mm	2602026	-	-
Special stainless steel plunger with extended handle				
5 μl	0.50 mm	-	2502304	-
10 μl	0.50 mm	-	2502404	-
25 μl	0.50 mm	-	2502504	-
50 μl	0.50 mm	-	2502604	-
100 μl	0.50 mm	-	2502704	-
250 μl	0.50 mm	-	2502804	-

HPLC Syringes

3. Valco VISF-1 Valves

Glass Barrel: Borosilicate 3.3
Precision: $\pm 1\%$ of the volume

Volume	Needle Tip Style Length O.D.	fixed b 19 mm	removable b 19 mm	TLL Luer-Lock
Flexible plunger				
5 μ l	0.72 mm	2163303	2163307	-
10 μ l	0.72 mm	2163403	2163407	-
Special stainless steel plunger				
5 μ l	0.72 mm	2103303	2103307	-
10 μ l	0.72 mm	2103403	2103407	-
25 μ l	0.72 mm	2103503	2103507	-
50 μ l	0.72 mm	2103603	2103607	2103609
100 μ l	0.72 mm	2103703	2103707	2103709
250 μ l	0.72 mm	2103803	2103807	2103809
500 μ l	0.72 mm	2103903	2103907	2103909
Special stainless steel plunger with PTFE-seal				
10 μ l	0.72 mm	2603403	2603407	-
25 μ l	0.72 mm	2603503	2603507	-
50 μ l	0.72 mm	2603603	2603607	2603609
100 μ l	0.72 mm	2603703	2603707	2603709
250 μ l	0.72 mm	2603803	2603807	2603809
500 μ l	0.72 mm	2603903	2603907	2603909
1.0 ml	0.72 mm	2603003	2603007	2603009

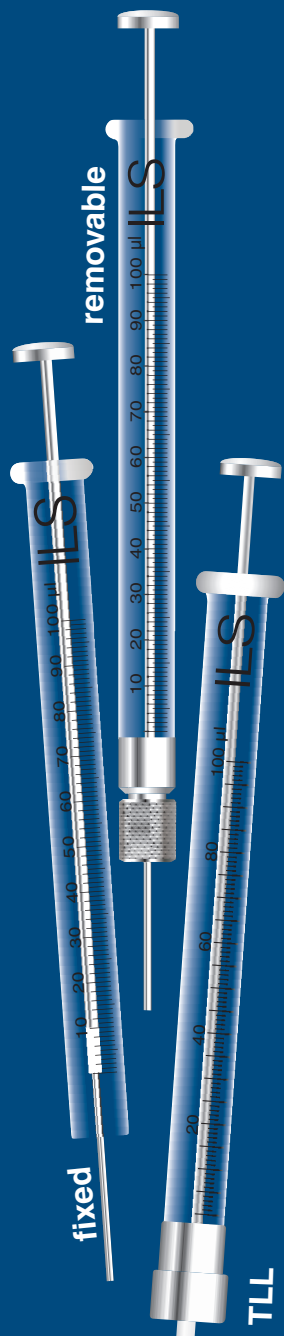

HPLC Syringes for Autosampler

1. Gynkotek Dionex Gina, Agilent (HP) 1090A, Hitachi

Plunger: Special stainless steel plunger with PTFE-seal

Glass Barrel: Borosilicate 3.3
Precision: $\pm 1\%$ of the volume

Gynkotek Dionex Gina

Volume	Needle Tip Style Length Series	removable a 51 mm O.D.	
25 μ l	H	0.72 mm	2606505
250 μ l	H	0.72 mm	2606805

Hewlett Packard 1090A/Agilent

Volume	Series	Front Fitting	
25 μ l	H	1/4"-28UNEF	2606500
250 μ l	H	1/4"-28UNEF	2606800

Hitachi L-7200/L-7250/AS2000/AS42000

Volume	Series	Front Fitting	
100 μ l	H	M10	2611711
500 μ l	H	M10	2611911
1.0 ml	H	M10	2611011
2.5 ml	H	M10	2611031

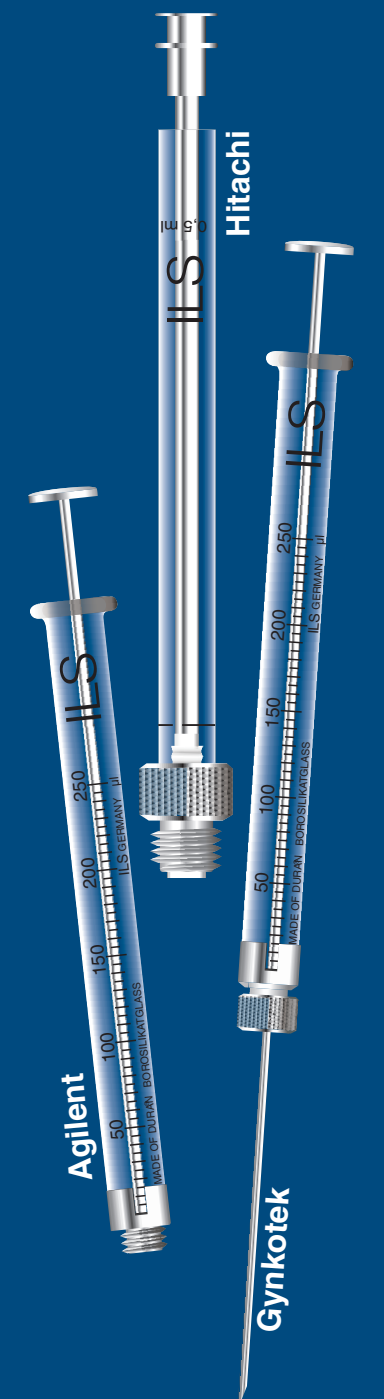

HPLC Syringes for Autosampler

2. Waters, Spark, Kontron

Plunger: Stainless steel with PTFE-seal

Glass Barrel: Borosilicate 3.3

Precision: < ±1% of the volume

Waters WISP®

plastic coated safety syringes

Volume	Series	Front Fitting / Plunger Top	
25 µl	H	¼"-28UNF / 4-40UNC	2663514
250 µl	H	¼"-28UNF / 4-40UNC	2663814

Spark

Volume	Series	Front Fitting	
25 µl	H	¼"-28UNF	2608517
50 µl	H	¼"-28UNF	2608617
100 µl	H	¼"-28UNF	2608717
250 µl	H	¼"-28UNF	2608817
500 µl	H	¼"-28UNF	2608917
1.0 ml	H	¼"-28UNF	2608017

Kontron

Volume	Series	Front Fitting	
250 µl	H	M8x0.75	2652816
500 µl	H	M8x0.75	2652916
1.0 ml	H	M8x0.75	2652016
2.5 ml	H	M8x0.75	2652036

Waters WISP®

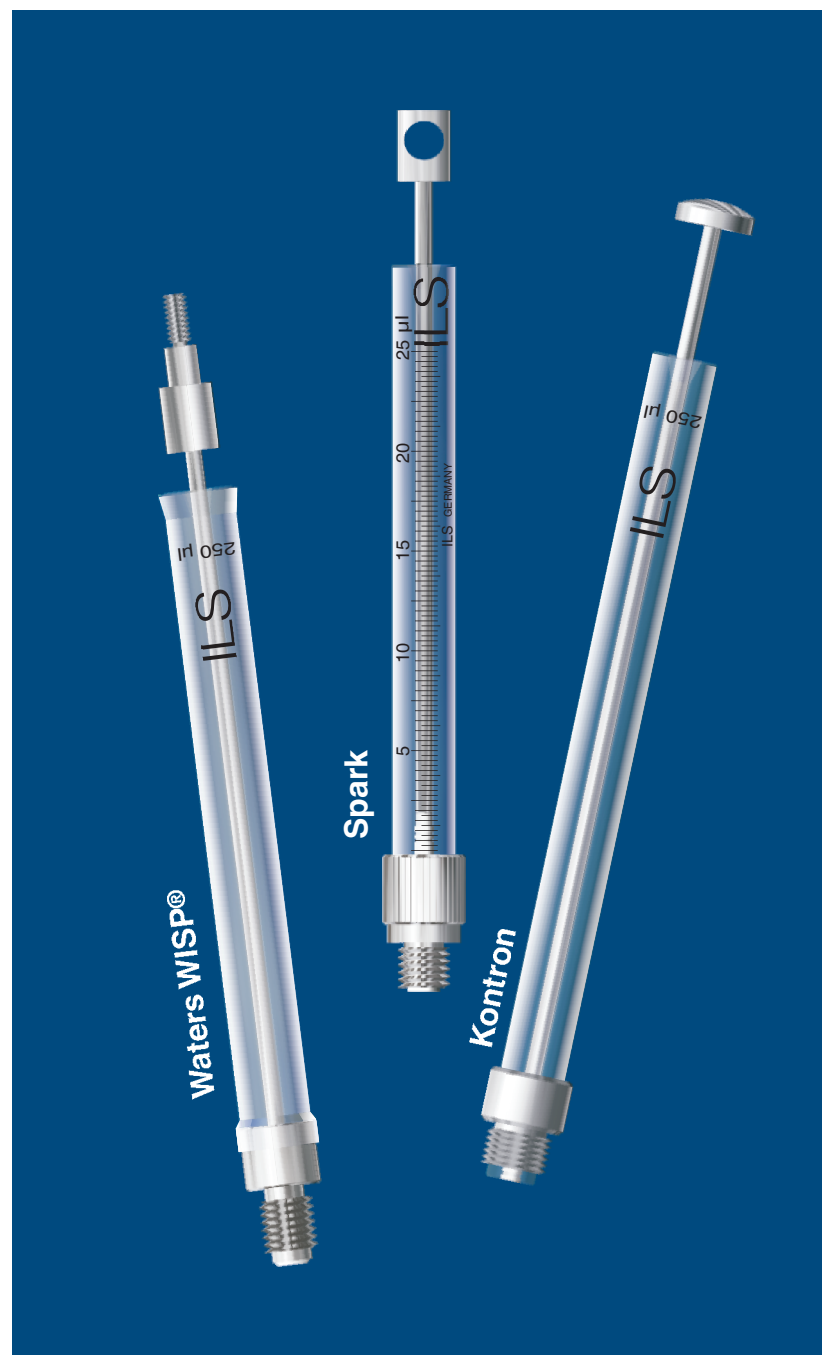

Kontron



WISP® is a registered trademark of Waters Corporation

HPLC Syringes for Autosampler

3. Perkin Elmer

Glass Barrel: Borosilicate 3.3
Precision: $\pm 1\%$ of the volume

Perkin Elmer Series 200 Autosampler

Volume	H-CX	H-C
Special stainless steel plunger with PTFE-seal		
50 μ l	2606615	-
250 μ l	2606815	-
500 μ l	2606915	-
1.0 ml	-	2606015
2.5 ml	-	2606035

Plunger Top

With thread
6-32 UNC



With thread
6-32 UNC



Front Fitting

Screw
1/4"x28 UNF



Screw
1/4"x28 UNF



HPLC Syringes for Autosampler

4. LEAP Technologies, CTC, Shimadzu

Glass Barrel: Borosilicate 3.3
Precision: $\pm 1\%$ of the volume

LEAP, CTC

Volume	Series	Gauge	Needle Tip Style Length O.D.	fixed b 51 mm
Stainless steel plunger				
10 μ l	N	22s	0.72 mm	2120402
Stainless steel plunger with PTFE-seal				
10 μ l	H	22s	0.72 mm	2606416
25 μ l	H	22s	0.72 mm	2620502
50 μ l	H	22s	0.72 mm	2620602
50 μ l	H	22	0.72 mm	2620605
100 μ l	H	22s	0.72 mm	2620702
100 μ l	H	22	0.72 mm	2620705
250 μ l	H	22	0.72 mm	2620805

Shimadzu SIL 6A

Volume	Series	Front Fitting	
Special stainless steel plunger with PTFE-seal			
100 μ l	H	1/4"x28UNEF	2606700

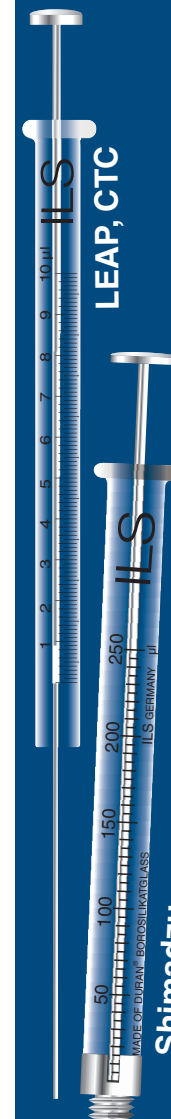



HPLC Syringes for Autosampler

5. Thermo Finnigan, Thermo Separation, Varian

Plunger: Stainless steel with PTFE-seal
 Glass Barrel: Borosilicate 3.3
 Precision: $\pm 1\%$ of the volume

Thermo Finnigan
 Thermo Separation SP 8780/SP 8875/SP 8880
 Thermo Separation AS 100/AS 300/AS 1000/AS 3000/AS 3500
 Varian 9090

Volume	Series	Front Fitting	
100 µl	H-C	¼"-28UNF	2606714
250 µl	H-C	¼"-28UNF	2606814
500 µl	H-C	¼"-28UNF	2606914
1.0 ml	H-C	¼"-28UNF	2606015
2.5 ml	H-C	¼"-28UNF	2606035

Syringes for TLC

CAMAG Linomat III and IV

Glass Barrel: Borosilicate 3.3
 Precision: $\pm 1\%$ of the volume
 Needle: especially developed for the needs of the Linomat III and IV

Main Use: Thin Layer Chromatography (TLC)

Volume	Needle fixed
Special stainless steel plunger with PTFE-seal	
100 µl	2606702
500 µl	2606902

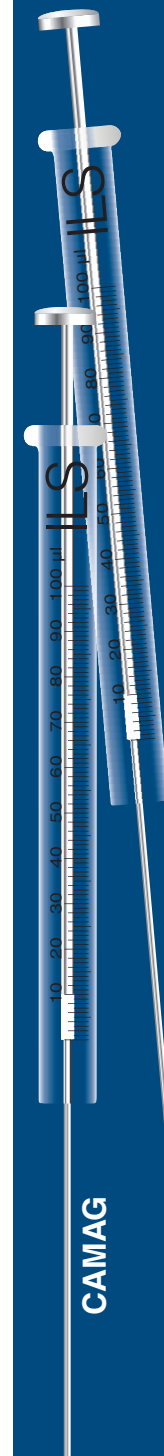

Syringes for Automatic Liquid Handling

1. PTFE-Seals, Chemically Resistant Heavy Duty Syringes

Plunger: PTFE-seal
 Glass Barrel: Borosilicate 3.3
 Precision: $\pm 1\%$ of the volume

Volume	AD	DAD	DX	C	CX	RQ
10 μ l	-	-	-	2606414	2606415	-
25 μ l	-	-	2607516	2606514	2606515	2607512
50 μ l	2605613	2607618	2607616	2606614	2606615	2607612
100 μ l	2605713	2607718	2607716	2606714	2606715	2607712
250 μ l	2605813	2607818	2607816	2606814	2606815	2607812
500 μ l	2605913	2607918	2607916	2606914	2606915	2607912
1.0 ml	2605014	2607018	2607016	2606015	-	2607014
2.5 ml	2605034	2607038	-	2606035	-	2607034
5.0 ml	2605054	-	-	2606055	-	2607054
10.0 ml	2605074	-	-	2606075	-	2607074
25.0 ml	2605094	-	-	2606095	-	-



AD

	With thread 6-32 UNC	With thread 6-32 UNC	With thread 6-32 UNC	With thread 6-32 UNC	+Screw
Plunger Top					
Side Connection					
Front Fitting	Screw M8x0.75	Screw M8x0.75	Luer	Screw 1/4"x28 UNF	Screw 1/4"x28 UNF



DAD

DX

C

CX

RQ

Syringes for Automatic Liquid Handling

1. PTFE-Seals, Chemically Resistant Heavy Duty Syringes

Plunger: PTFE-seal
 Glass Barrel: Borosilicate 3.3
 Precision: $\pm 1\%$ of the volume

Volume	TLL	TLL-X	H-KP	XL	H-Gi 402	H-Gi 401
25 μ l	2607509	2607517	2608515	2607511	-	-
50 μ l	2607609	2607617	2608615	2607611	-	-
100 μ l	2607709	2607717	2608715	2607711	2629710	-
250 μ l	2607809	2607817	2608815	2607811	2629810	-
500 μ l	2607909	2607917	2608915	2607911	2629910	2629911
1.0 ml	2607011	2607017	2608015	2607013	2629015	-
2.5 ml	2607031	2607037	2608035	2607033	2629031	-
5.0 ml	2607051	2607057	2608055	2607053	2629051	-
10.0 ml	2607071	2607077	2608075	2607073	2629071	2629073
25.0 ml	2607091	-	2608091	2607096	-	-
50.0 ml	2607101	-	-	2607103	-	-
100.0 ml	2607121	-	-	-	-	-

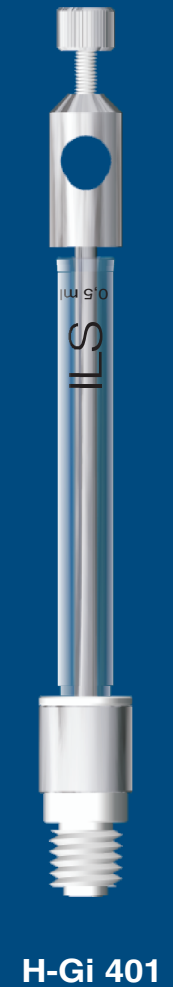
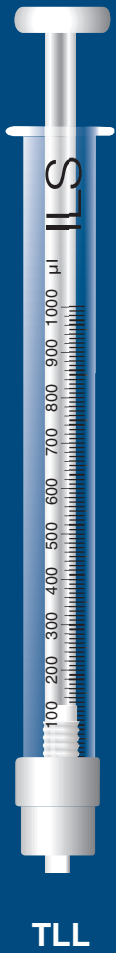
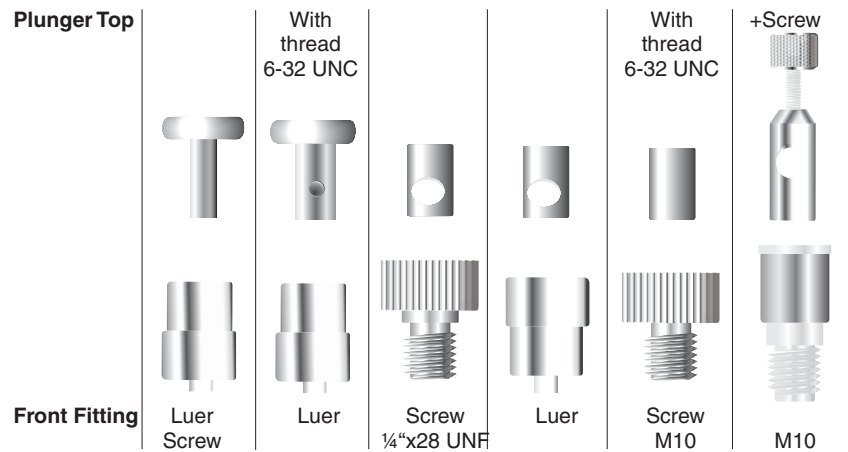

Syringes for Automatic Liquid Handling

1. PTFE-Seals, Chemically Resistant Heavy Duty Syringes

Plunger: PTFE-seal
 Glass Barrel: Borosilicate 3.3
 Precision: $\pm 1\%$ of the volume

Volume	H-PD	XE	XP
12.5 μ l	2658415	-	-
25 μ l	2658515	-	2607515
50 μ l	2658615	-	2607615
100 μ l	2658715	-	2607715
125 μ l	2658714	-	-
250 μ l	2658815	-	2607815
500 μ l	2658915	2607921	2607915
1.0 ml	2658014	2607021	2607015
1.25 ml	2658015	-	-
2.5 ml	2658035	2607041	2607035
5.0 ml	2658055	2607061	2607075
12.5 ml	2658074	-	-

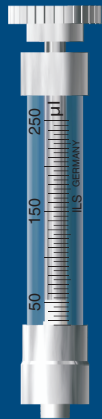

H-PD

Plunger Top

With thread
6-32 UNC



Front Fitting

Luer



Screw
1/4"x28 UNF



Screw
1/4"x28 UNF



H-PD

XE

XP



XP

Syringes for Automatic Liquid Handling

2. Modified PTFE-Seals for Buffers

Specially designed for handling of strong buffers and other aqueous solutions. The modified PTFE-seals guarantee extended lifetime under heavy duty conditions.

Plunger: PTFE-seal
Glass Barrel: Borosilicate 3.3
Precision: < ±1% of the volume

Volume	AD	DAD	DX	C	CX
25 µl	-	-	2627517	2606517	2606527
50 µl	2605617	2626617	2627617	2606617	2606627
100 µl	2605717	2626717	2627717	2606717	2606727
250 µl	2605817	2626817	2627817	2606817	2606827
500 µl	2605917	2626917	2627917	2606917	2606927
1.0 ml	2605017	2626017	2627017	2606017	-
2.5 ml	2605037	2626037	-	2606037	-
5.0 ml	2605057	-	-	2606057	-
10.0 ml	2605077	-	-	2606077	-

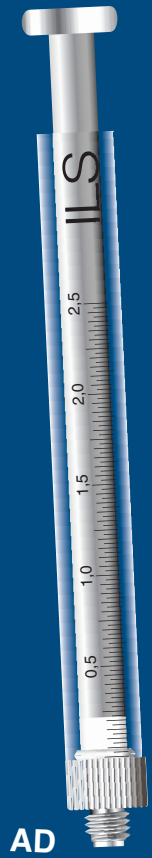

AD

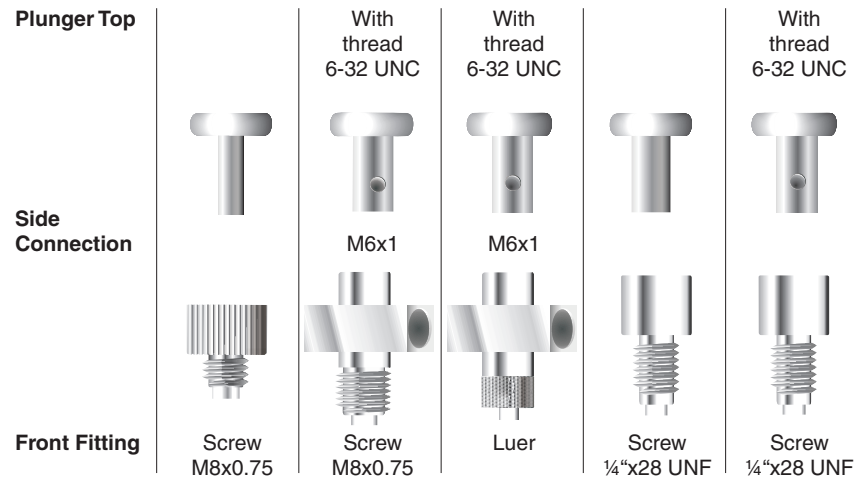

DAD

DX

C

CX

C

Syringes for Automatic Liquid Handling

2. Modified PTFE-Seals for Buffers

Specially designed for handling of strong buffers and other aqueous solutions. The modified PTFE-seals guarantee extended lifetime under heavy duty conditions.

Plunger: PTFE-seal
Glass Barrel: Borosilicate 3.3
Precision: < ±1% of the volume

Volume	TLL	TLL-X	RQ	XL
25 µl	2641517	2643517	2644517	2645517
50 µl	2641617	2643617	2644617	2645617
100 µl	2641717	2643717	2644717	2645717
250 µl	2641817	2643817	2644817	2645817
500 µl	2641917	2643917	2644917	2645917
1.0 ml	2641017	2643017	2644017	2645017
2.5 ml	2641037	2643037	2644037	2645037
5.0 ml	2641057	2643057	2644057	2645057
10.0 ml	2641077	2643077	2644077	2645077

Plunger Top

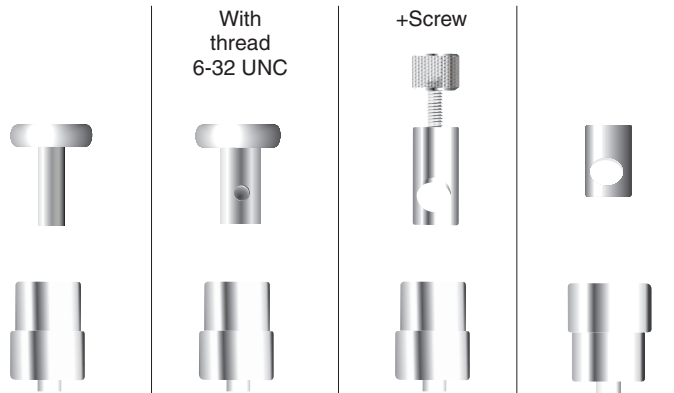

With thread 6-32 UNC

+Screw

Front Fitting

Luer Luer Luer Luer

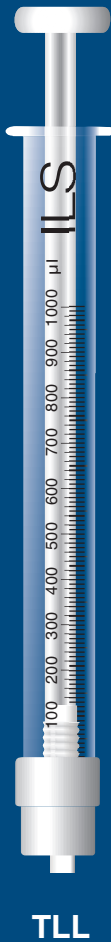

Syringes for Automatic Liquid Handling

2. Modified PTFE-Seals for Buffers

Specially designed for handling of strong buffers and other aqueous solutions. The modified PTFE-seals guarantee extended lifetime under heavy duty conditions.

Plunger: PTFE-seal
Glass Barrel: Borosilicate 3.3
Precision: < ±1% of the volume

Volume	H-PD	XE	XP
12.5 µl	2666415	-	-
25 µl	2666515	-	2647517
50 µl	2666615	-	2647617
100 µl	2666715	-	2647717
125 µl	2666714	-	-
250 µl	2666815	-	2647817
500 µl	2666915	2646927	2647917
1.0 ml	2666014	2646027	2647017
1.25 ml	2666015	-	-
2.5 ml	2666035	2646047	2647037
5.0 ml	2666055	2646067	2647077
12.5 ml	2666074	-	-



H-PD

Plunger Top

With thread
6-32 UNC



Front Fitting

Luer



Screw
¼"x28 UNF



Screw
¼"x28 UNF



XP

Syringes for Automatic Liquid Handling

3. Special PE-Seals for Smoother Operation

Specially designed for handling of strong buffers and other aqueous solutions. The special PE-seals run smoother than conventional seals. Good resistance to buffers and aqueous solutions, long lifetime.

Plunger: PE-seal (Polyethylene)

Glass Barrel: Borosilicate 3.3

Precision: < ±1% of the volume

Volume	AD	DAD	DX	C	CX
50 µl	2605618	2626618	2627618	2606618	2606628
100 µl	2605718	2626718	2627718	2606718	2606728
250 µl	2605818	2626818	2627818	2606818	2606828
500 µl	2605918	2626918	2627918	2606918	2606928
1.0 ml	2605018	2626018	2627018	2606018	-
2.5 ml	2605038	2626038	-	2606038	-
5.0 ml	2605058	-	-	2606058	-
10.0 ml	2605078	-	-	2606078	-



AD

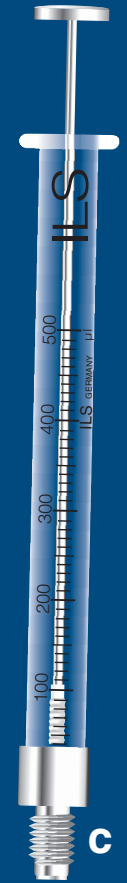
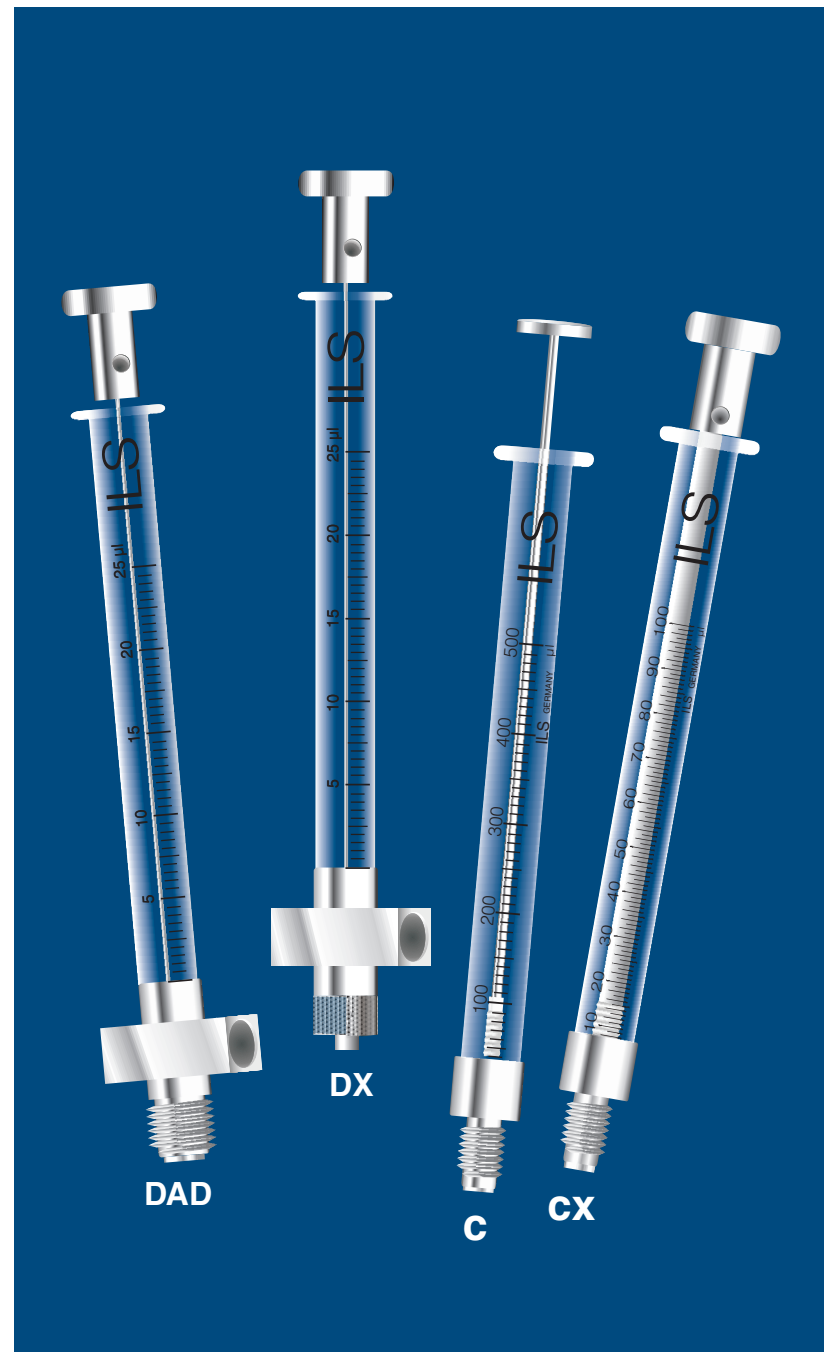
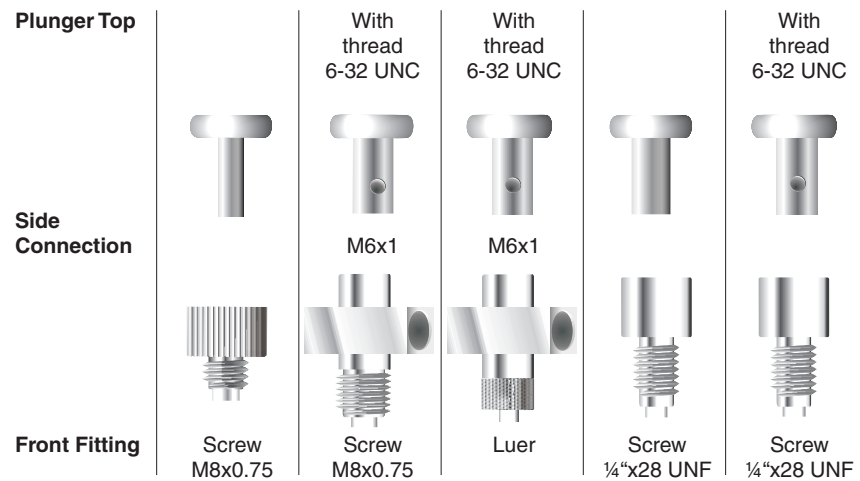

C

Syringes for Automatic Liquid Handling

3. Special PE-Seals for Smoother Operation

Specially designed for handling of strong buffers and other aqueous solutions. The special PE-seals run smoother than conventional seals. Good resistance to buffers and aqueous solutions, long lifetime.

Plunger: PE-seal (Polyethylene)

Glass Barrel: Borosilicate 3.3

Precision: < ±1% of the volume

Volume	TLL	TLL-X	H-KP	RQ	XL
50 µl	2641618	2643618	2608616	2644618	2645618
100 µl	2641718	2643718	2608716	2644718	2645718
250 µl	2641818	2643818	2608816	2644818	2645818
500 µl	2641918	2643918	2608916	2644918	2645918
1.0 ml	2641018	2643018	2608016	2644018	2645018
2.5 ml	2641038	2643038	2608036	2644038	2645038
5.0 ml	2641058	2643058	2608056	2644058	2645058
10.0 ml	2641078	2643078	2608076	2644078	2645078

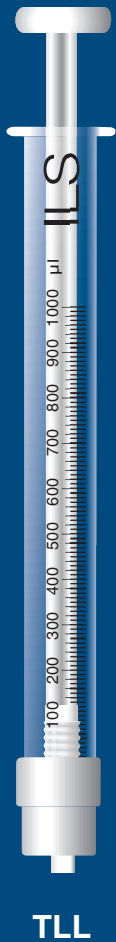
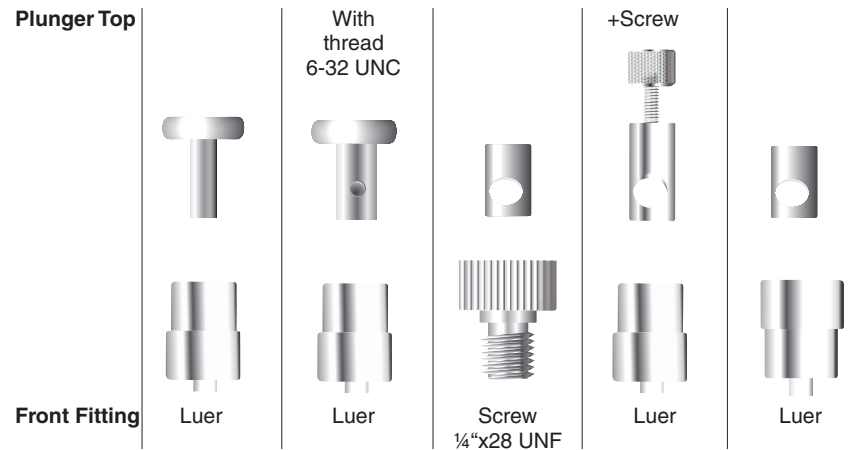

Syringes for Automatic Liquid Handling

3. Special PE-Seals for Smoother Operation

Specially designed for handling of strong buffers and other aqueous solutions. The special PE-seals run smoother than conventional seals. Good resistance to buffers and aqueous solutions, long lifetime.

Plunger: PE-seal (Polyethylene)

Glass Barrel: Borosilicate 3.3

Precision: < ±1% of the volume

Volume	H-PD	XE	XP
25 µl	2665515	-	-
50 µl	2665615	-	2647618
100 µl	2665715	-	2647718
125 µl	2665714	-	-
250 µl	2665815	-	2647818
500 µl	2665915	2646928	2647918
1.0 ml	2665014	2646028	2647018
1.25 ml	2665015	-	-
2.5 ml	2665035	2646048	2647038
5.0 ml	2665055	2646068	2647078

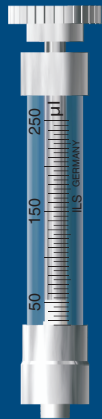

H-PD

Plunger Top

With thread
6-32 UNC



Front Fitting

Luer



Screw
1/4"x28 UNF

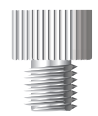

Screw
1/4"x28 UNF



H-PD

XE

XP



XP

Syringes for Automatic Liquid Handling

4. ABI, Abbott, Selectra, H-I, Varian

Plunger: Stainless steel with PTFE-seal

Glass Barrel: Borosilicate 3.3

Precision: $\pm 1\%$ of the volume

ABI PRISM® for Genetic Analyser

Volume	Series	Front Fitting	
1 ml	H	¼"-32 UNEF	2618011

Syringe for Abbott CELL-DYN®

Volume	Series	Front Fitting	
10 ml	H	TLL	2607081

Syringe for Selectra

Volume	Series	Front Fitting	
100 µl	H	M8x0.75	2605714
500 µl	H	M8x0.75	2605914
1.0 ml	H	M8x0.75	2605013

H-I

Volume	Series	Front Fitting	
250 µl	HI	¼"-28 UNEF	2623815
500 µl	HI	¼"-28 UNEF	2623915
1.0 ml	HI	¼"-28 UNEF	2623015

Varian

Volume	Series	Front Fitting	
100 µl	H	GPC M8x1	2607706

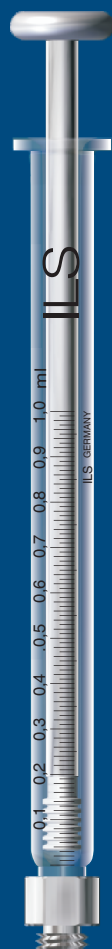

ABI

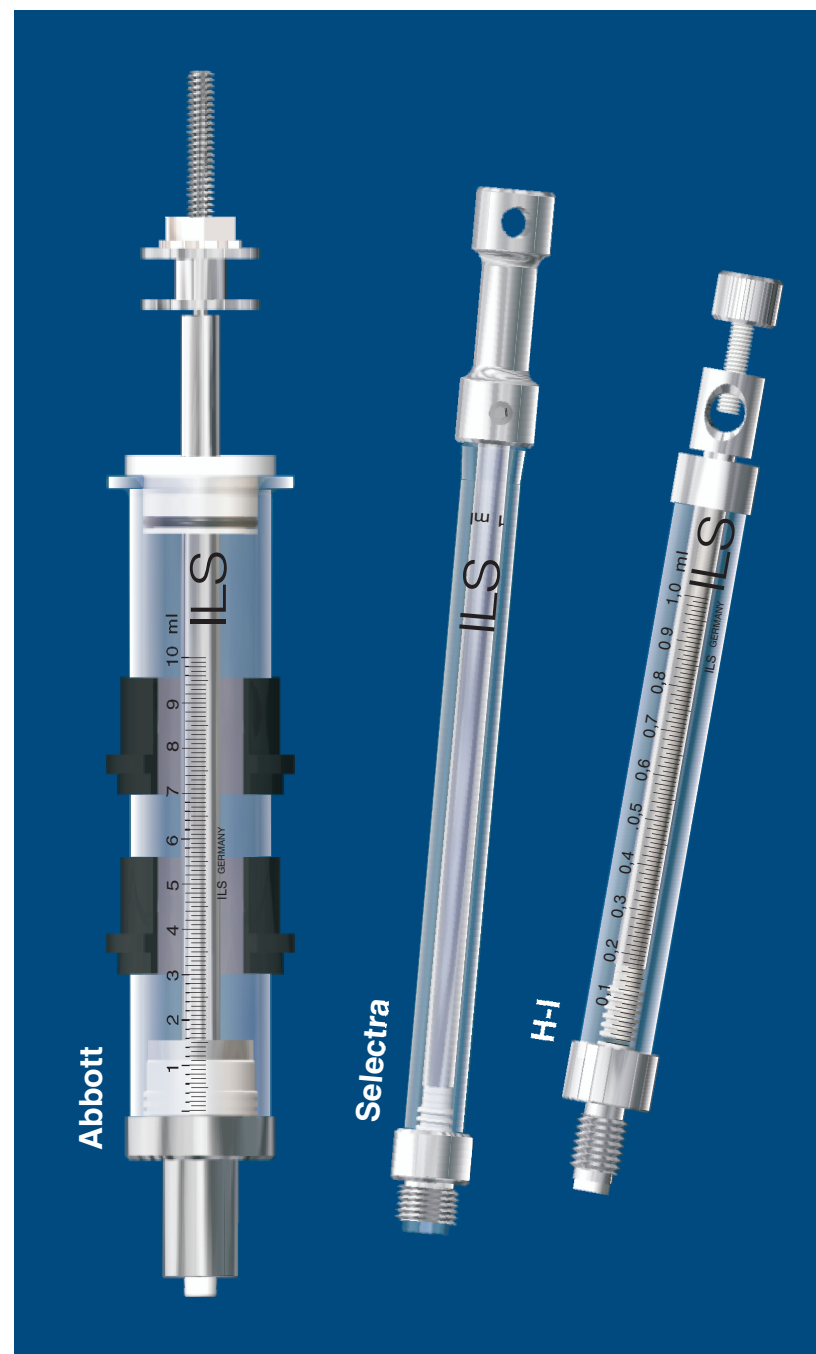

Varian

ABI PRISM® is a registered trademark of Perkin Elmer, USA
CELL-DYN® is a registered trademark of Abbott Laboratories, USA

Syringes for Robbins Hydra®

Plunger: Stainless steel with PTFE-seal
 Glass Barrel: Borosilicate 3.3
 Needle: PTFE coated
 Precision: < ±1% of the volume

Hydra® 96

Volume	Series	Needle Tip Style O.D. x I.D.	fixed b
100 µl	H	0.45 x 0.25	2615700
290 µl	H	0.7 x 0.40	2615800
580 µl	H	0.7 x 0.40	2615900
1 ml	H	0.7 x 0.40	2615100

R/B

290 µl	H	1.2 x 0.80	2615810
580 µl	H	1.2 x 0.80	2615910
1 ml	H	1.2 x 0.80	2615110

Hydra® 384

100 µl	H	0.45 x 0.25	2615760
--------	---	-------------	---------

Hydra® 384 Glasbarrel with Metal Jacket

100 µl	H	0.45 x 0.25	2615764
--------	---	-------------	---------

Syringes for Robbins Hydra®

Replacement PTFE-Tips (seals)

Hydra® 96

Volume	Needle Tip Style PTFE O.D. x I.D.	PTFE-Tip 10/Pack	PTFE-Tip 50/Pack	PTFE-Tip 100/Pack
100 µl	0.45 x 0.25	2615702	2615705	2615709
290 µl	0.7 x 0.40	2615802	2615805	2615809
580 µl	0.7 x 0.40	2615902	2615905	2615909
1 ml	0.7 x 0.40	2615102	2615105	2615109

R/B

290 µl	1.2 x 0.80	2615812	2615815	2615819
580 µl	1.2 x 0.80	2615912	2615915	2615919
1 ml	1.2 x 0.80	2615112	2615115	2615119

Hydra® 384

100 µl	0.45 x 0.25	2615702	2615705	2615709
--------	-------------	---------	---------	---------

Hydra® is a registered trademark of Robbins Scientific, USA

Hydra® is a registered trademark of Robbins Scientific, USA

Syringes with PEEK-Tubing Connectors

Plunger: PTFE-seal
Glass Barrel: Borosilicate 3.3
Precision: < ±1% of the volume
 - direct connection
 - reduced dead volume
 - totally inert, no metal contact
 - fits any tube from 0.8 to 3.2 mm Ø
 - highly resistant

Volume	Series	Connector		
10 µl	H	M6	tubing connector	2624414
25 µl	H	M6	tubing connector	2624514
50 µl	H	M6	tubing connector	2624614
100 µl	H	M6	tubing connector	2624714
250 µl	H	M6	tubing connector	2624814
500 µl	H	M6	tubing connector	2624914
1.0 ml	H	M6	tubing connector	2624015
2.5 ml	H	M6	tubing connector	2624035
5.0 ml	H	M6	tubing connector	2624055
10.0 ml	H	M6	tubing connector	2624075

Volume	Series	Connector		
10 µl	H	1/4 x 28"	tubing connector	2624415
25 µl	H	1/4 x 28"	tubing connector	2624515
50 µl	H	1/4 x 28"	tubing connector	2624615
100 µl	H	1/4 x 28"	tubing connector	2624715
250 µl	H	1/4 x 28"	tubing connector	2624815
500 µl	H	1/4 x 28"	tubing connector	2624915
1.0 ml	H	1/4 x 28"	tubing connector	2624016
2.5 ml	H	1/4 x 28"	tubing connector	2624036
5.0 ml	H	1/4 x 28"	tubing connector	2624056
10.0 ml	H	1/4 x 28"	tubing connector	2624076

Supplied with PEEK female screw connector, no tubing, no screw

Accessories for Connectors

Male Fittings, 10 per Pack

Thread	for Tubing with O.D.	
M 6	3.2 mm (1/18")	4130005
1/4x28"	3.2 mm (1/18")	4130020
M 6	1.6 mm (1/16")	4130016
1/4x28"	1.6 mm (1/16")	4130019

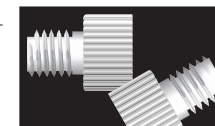

Washers, 10 per Pack

for Tubing with O.D.		
3.2 mm		4132032
1.6 mm		4132016



Complete sets

Set size	Description	
Set 3.2 x 1.6	tubing 3.2 x 1.6 + fitting M 6 + washer	4133032
Set 3.2 x 1.6	tubing 3.2 x 1.6 + fitting 1/4 x 28" + washer	4133033
Set 1.6 x 0.8	tubing 1.6 x 0.8 + fitting M 6 + washer	4133168
Set 1.6 x 0.8	tubing 1.6 x 0.8 + fitting 1/4 x 28" + washer	4133169
Set 1.6 x 0.5	tubing 1.6 x 0.5 + fitting M 6 + washer	4133165
Set 1.6 x 0.5	tubing 1.6 x 0.5 + fitting 1/4 x 28" + washer	4133166



Fitting Plug

Washer



Tubing Connector

Syringes with Adjustable Internal Stopper

Plunger: Stainless steel with PTFE-seal
Glass Barrel: Borosilicate 3.3
Precision: < ±1% of the volume
 - excellent for routine dosages
 - internal index stop is adjustable to any volume
 - for faster work and better reproducibility

TLL PTFE-Luer-Lock

Volume	Series	Description	
2.5 ml	H-TLL	with stopper	2614031
5.0 ml	H-TLL	with stopper	2614051
10.0 ml	H-TLL	with stopper	2614071

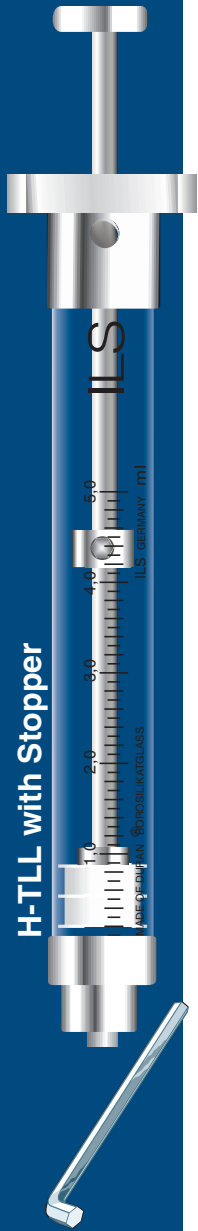

Syringes with Adjustable Internal Stopper

Plunger: Stainless steel with PTFE-seal
Glass Barrel: Borosilicate 3.3
Precision: < ±1% of the volume
 - excellent for routine dosages
 - internal index stop is adjustable to any volume
 - for faster work and better reproducibility

TLT PTFE-Luer-Tip

Volume	Series	Description	
2.5 ml	H-TLT	with stopper	2614034
5.0 ml	H-TLT	with stopper	2614054
10.0 ml	H-TLT	with stopper	2614074

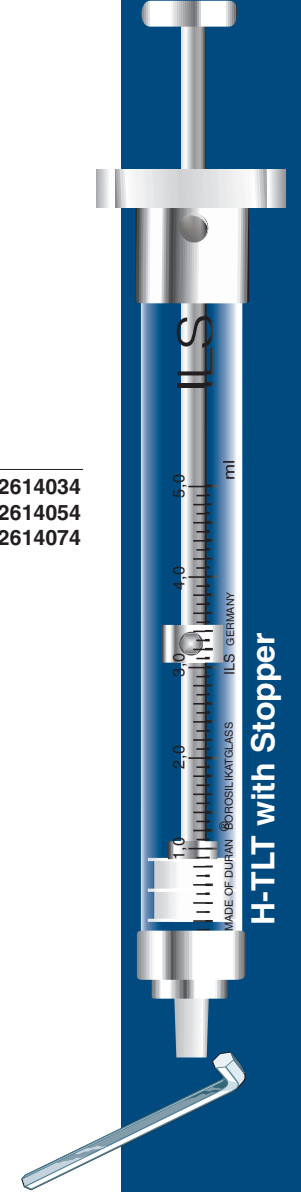

Accessories

Fitting Plug

Fittings, 10 per Pack

Thread	for Tubing with O.D.	
M 6	3.2 mm (1/18")	4130005
1/4 x 28"	3.2 mm (1/18")	4130020
M 6	1.6 mm (1/16")	4130016
1/4 x 28"	1.6 mm (1/16")	4130019
M 6	2.7 mm	4130004
1/4 x 28"	2.7 mm	4130025

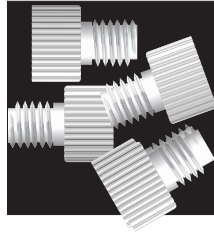

Washers, 10 per Pack

for Tubing with O.D.

3.2 mm	4132032
1.6 mm	4132016
2.7 mm	4132031



Washer

Plugs for Valves, 10 per Pack

Thread	
M 6	4130021
1/4 x 28"	4130022

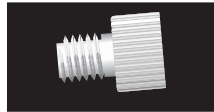

Female Luer Caps, 10 per Pack

2702206

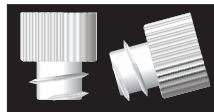

Syringe Guide, Rack, Cleaning Wires

Syringe Guide

made of stainless steel and anodized aluminum

2700001

Cleaning Wires, 12 per Pack

Gauge	O.D.	
26s, 31, 33	0.09 mm	21018300
22s, 25s, 28, 30	0.13 mm	21018301
27	0.16 mm	21018302
24, 26	0.20 mm	21018303

Syringe Rack

for 3 syringes

2700002

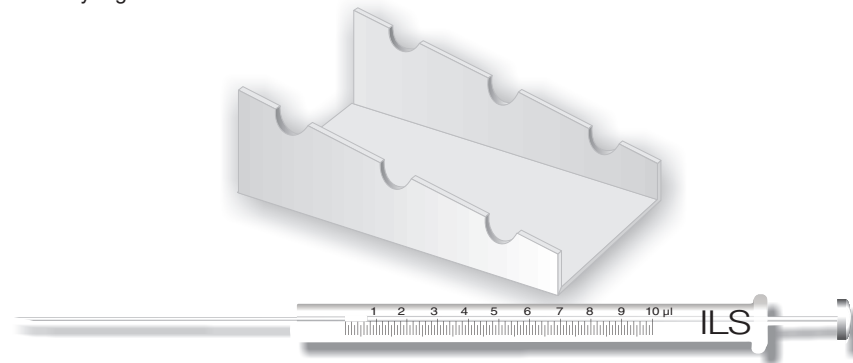

Guide

