

# Sterilin®

 **I.C.T., S.L.**  
INSTRUMENTACIÓN CIENTÍFICO TÉCNICA

## Single Use Plastics featuring Iwaki® Cell Biology

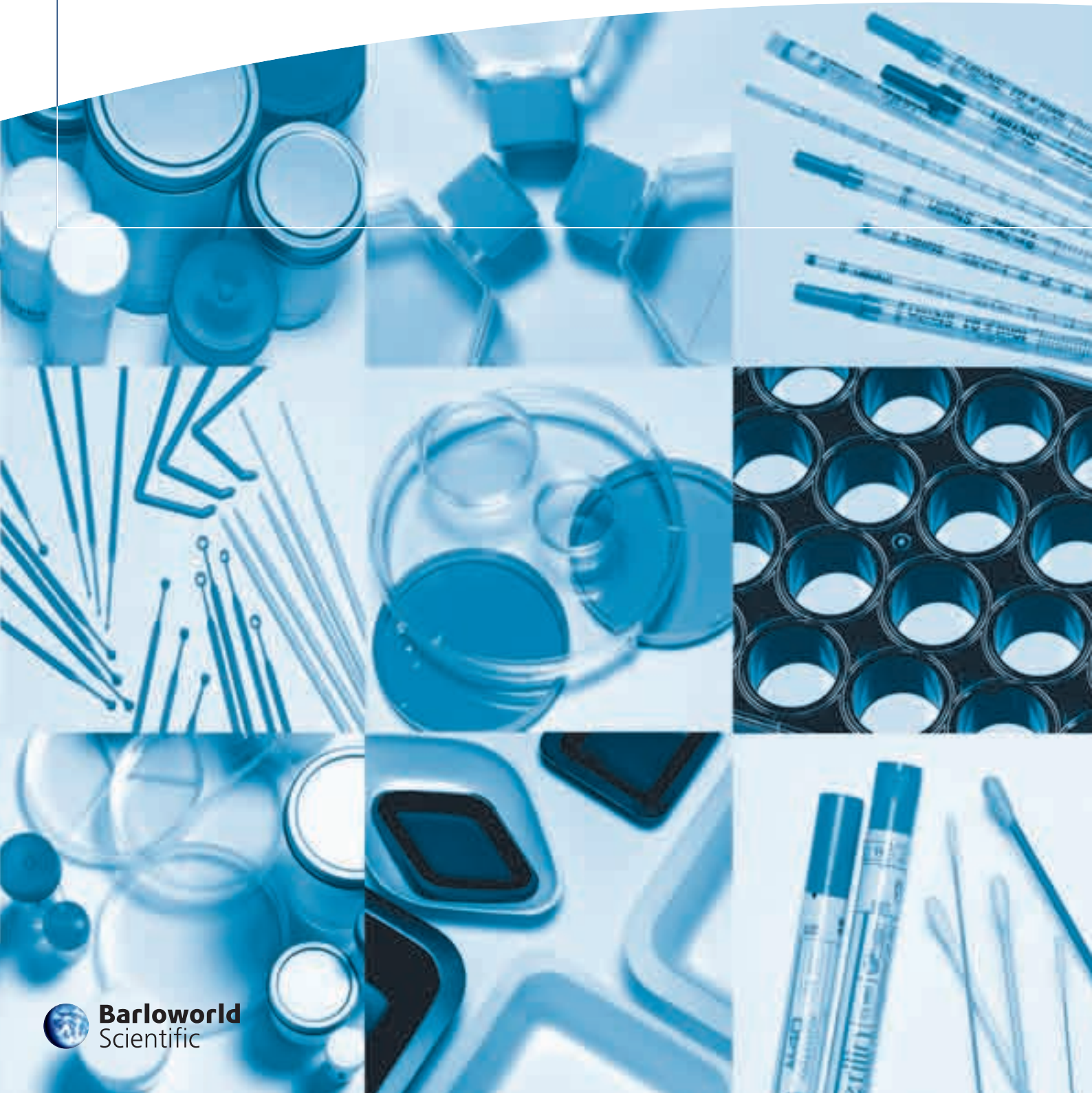

# Contents

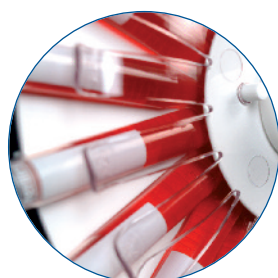
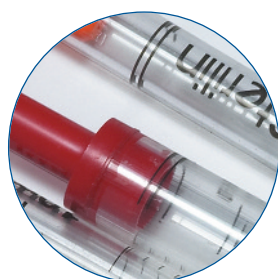
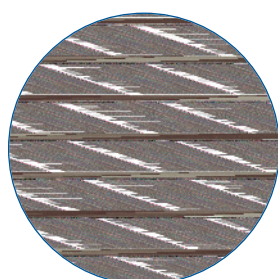

iii	Introduction
1	Bags
5	Bench protection
7	Bottles
9	Containers
21	Cuvettes
23	Dippers
25	Jars
27	Inoculating loops, needles and spreaders
29	Microtitre plates
31	Petri dishes
37	Pipettes
45	Pipette tips
49	Swabs
57	Tubes and vials
67	Weighing boats
71	Iwaki® Cell biology
83	Technical Information
96	Index (by catalogue number)
100	Index (alphabetical)







For more than forty years the Sterilin® brand has set world standards for quality, reliability and user safety in the field of single use laboratory plastics.

This, our biggest and most comprehensive catalogue ever, contains over 800 single-use products for microbiology and the life sciences. With over 100 new products and an extensive and much improved Technical Information section, this new catalogue provides all of information required to help support your day to day work.

For life scientists we have included an extensive range of Iwaki® cell biology products. Iwaki® branded tissue culture products, from leading edge Japanese company ATG, offer an incomparable level of product quality, innovation, service and support for cell biologists.

Sterilin® products are manufactured at our ISO 9001:2000 accredited plant in South Wales, UK, where a commitment to continuous product development and investment in injection moulding technology, clean room and microbiological research facilities ensure that every item is made to the highest possible quality, the same high specification that scientists have come to expect from the Sterilin® brand.

All of the products featured in this catalogue are available via an extensive worldwide network of laboratory dealers. Technical advice and guidance on product selection is available from our website





## Bags



## Bags, Autoclave, 121°C

- Specifically designed for contaminated waste disposal in autoclaves or incinerators
- Suitable for sterilisation at 121°C
- Convenient "tissue box" cartons dispense bags individually
- Strong disposable bags with blue biohazard printing

Product Code	Description	Max Temp (°C)	Width x Length (mm)	Material	Case Qty
509	Autoclave Bag	121	305 x 660	HDPE	200
510	Autoclave Bag	121	305 x 660	HDPE	500
509L	Autoclave Bag	121	406 x 610	HDPE	200
510L	Autoclave Bag	121	406 x 610	HDPE	500
511	Autoclave Bag	121	610 x 810	HDPE	200



## Bags, Autoclave, 135°C

- High temperature bags for the decontamination and inactivation of particularly resistant biological waste
- Suitable for high temperature sterilisation at 135°C
- Specifically designed for contaminated waste disposal in autoclaves or incinerators
- Convenient "tissue box" cartons dispense bags individually
- Strong disposable bags with blue biohazard printing

Product Code	Description	Max Temp (°C)	Width x Length (mm)	Material	Case Qty
509HT	Autoclave Bag	135	307 x 660	PP	200
510HT	Autoclave Bag	135	307 x 660	PP	500
509LHT	Autoclave Bag	135	406 x 610	PP	200
510LHT	Autoclave Bag	135	406 x 610	PP	500
511HT	Autoclave Bag	135	610 x 810	PP	200



Cardboard holder

## Bags, Autoclave, Holders

- Coated wire or cardboard holders for use with autoclave bags

Product Code	Description	Material	Case Qty
S23B	Holder for 511 bags	Cardboard	10
S23C	Holder for 509 & 510 bags	Coated Wire	1
S23E	Holder for 511 bags	Coated Wire	1

## Bags, Autoclave, Holders (continued)

- i** For advice on the use of autoclave bags please refer to page 84 of the Technical Information section



Coated wire holder

## Bags, Sampling, Metal Closure

- Ideal for sampling in cosmetic, pharmaceutical, food and veterinary laboratories
- Strong and elastic, bags can hold solid, semi-solid and liquid samples
- Puncture proof tabs ensure safety of operation
- Leak proof once sealed
- Write on area for sample identification

Product Code	Description	Capacity (ml)	Width x Length (mm)	Sterility	Material	Case Qty
MPE0712	Sampling bags	60	76 x 127	EO	PE/ME	500
MPE0717	Sampling bags	120	76 x 178	EO	PE/ME	500
MPE1730	Sampling bags	1650	178 x 305	EO	PE/ME	500
MPE2530	Sampling bags	1800	254 x 305	EO	PE/ME	500



- i** For method of use please refer to page 84 of the Technical Information section







## Bags, Homogeniser

- Ideal for homogenising food samples prior to microbiological analysis
- Sterilin Steriblend® bags are double sealed for strength and reliability ensuring safe homogenisation of samples
- Suitable for use in all leading homogeniser machines
- Manufactured from food grade low density polyethylene and gamma irradiated to ensure sterility
- Heavy gauge polyethylene for strength

Product Code	Description	Capacity (ml)	Width x Length (mm)	Sterility	Inner Pack Qty	Case Qty
S400	Homogeniser Bag	400	180 x 300	IRR	50	500
S405	Homogeniser Bag	400	180 x 300	IRR	5	500
S408	Homogeniser Bag	80	100 x 150	IRR	50	1000
S435	Homogeniser Bag	3500	380 x 508	IRR	50	500



# BENCH



## Bench Protection



## BenchGuard

- Highly absorbent paper ideal for protecting benches and surfaces against liquid spills
- One side plastic coated to prevent soak through
- Available in roll or sheet form
- Rolls supplied in easy to use dispenser packs

Product Code	Description	Absorption (ml/m <sup>2</sup> )	Length x Width (m)	Pack Type	Case Qty
BG50	BenchGuard	400	50 x 0.49	Roll	1
BG92	BenchGuard	400	50 x 0.92	Roll	1
BG60	BenchGuard	400	0.60 x 0.49	Sheets	50



## BenchGuard Extra

- BenchGuard Extra has double the absorbency of standard BenchGuard for use in more demanding applications
- One side plastic coated to prevent soak through
- Available in roll or sheet form
- Rolls supplied in easy to use dispenser packs

Product Code	Description	Absorption (ml/m <sup>2</sup> )	Length x Width (m)	Pack Type	Case Qty
BG50E	BenchGuard Extra	800	50 x 0.49	Roll	1
BG60E	BenchGuard Extra	800	0.60 x 0.49	Sheets	50

For more information about the Sterilin® disposable plastics range visit [www.sterilin.co.uk](http://www.sterilin.co.uk)



# Bottles





## Bottles, Water Sampling, Polystyrene

- Blow moulded from flexible polystyrene
- Convenient way of sampling both chlorinated and non-chlorinated water for microbiological analysis
- Sterile by gamma irradiation
- Available empty or pre-dosed with sodium thiosulphate
- Dosed bottle (20mg/litre) is suitable for neutralising samples of low chlorinated water
- Dosed versions have the 12 month expiry date clearly printed on each bottle label
- Colour coded labels allows for easy identification of dosed and undosed samples
  - Blue – dosed
  - Green – undosed
- Tamper evident cap for sample integrity
- Lot number for complete traceability

Product Code	Description	Capacity (ml)	Material	Sterility	Case Qty
500WSC	Bottle, dosed	500	PS	IRR	70
500WSCNT	Bottle, undosed	500	PS	IRR	70



## Bottles, Water Sampling, PETGN

- Manufactured from robust, non-toxic PETG which has excellent clarity
- Octagonal shape facilitates ease of handling, transport and storage
- Available in three sizes – 250ml, 500ml, 1000ml
- Sterile by gamma irradiation
- Available empty or pre-dosed with sodium thiosulphate
- Dosed bottle (120mg/litre) conforms to ISO 5667-3 and is suitable for neutralising high chlorinated water, including swimming pools
- Colour coded caps allow for easy identification of dosed and undosed samples
  - Blue – dosed
  - White – undosed
- Dosed versions have the 12 month expiry date clearly printed on each bottle
- Tamper evident cap for sample integrity
- Lot number for complete traceability

Product Code	Description	Capacity (ml)	Cap Colour	Material	Sterility	Case Qty
250PETN	Bottle, dosed	250	Blue	PETG	IRR	162
250PETNTN	Bottle, undosed	250	White	PETG	IRR	162
500PETN	Bottle, dosed	500	Blue	PETG	IRR	80
500PETNTN	Bottle, undosed	500	White	PETG	IRR	80
1000PETN	Bottle, dosed	1000	Blue	PETG	IRR	48
1000PETNTN	Bottle, undosed	1000	White	PETG	IRR	48



# Containers



## Containers, Polystyrene, 7ml Bijou



- Ideal for small volume samples
- CE marked in accordance with the European Directive 98/79/EC
- For in vitro use only
- Leakproof – tested in accordance with EN14254 Annexe D and BS5213
- Available pre-filled with boric acid (0.09g) for the preservation of urine samples
- Aseptically manufactured under cleanroom conditions (class 7 ISO 14644) to exclude microbiological contamination
- Manufactured from virgin polystyrene. All materials are non-cytotoxic
- Suitable for centrifugation at 7,200 x g

Product Code	Description	Capacity (ml)	Label	Materials Base/Cap	Sterility	Case Qty
129A	Container	7	No	PS/PE	AS	700
129B	Container	7	Plain	PS/PE	AS	700
129BBAC	Container + boric acid	7	Printed	PS/PE	AS	700



## Containers, Polystyrene, 7ml Bijou with Coverslip



- Ideal for work on the culture of intracellular organisms (eg. Chlamydia trachomatis, Rickettsia etc)
- Coverslip enables the growth of a monolayer of cells into which the intracellular organism has been infected
- Glass coverslip can be removed for examination/study
- CE marked in accordance with the European directive 98/79/EC
- For in vitro use only
- Small convenient size
- Aseptically manufactured under cleanroom conditions (class 7 ISO 14644) to exclude microbiological contamination
- Manufactured from virgin polystyrene. All materials are non-cytotoxic

Product Code	Description	Capacity (ml)	Label	Materials Base/Cap	Sterility	Case Qty
129AX/1	Container with coverslip	7	No	PS/PE	AS	700
129BX/1	Container with coverslip	7	Plain	PS/PE	AS	700



## Containers, Polystyrene, 30ml Universal



- CE marked in accordance with the European Directive 98/79/EC
- For in vitro use only
- Product is free standing with a conical base ideal for pellet formation
- Unique leak tight cap ensures excellent sample containment. Leak tested in accordance with EN14254 Annex D and BS5213
- Suitable for centrifugation at 3,800 x g
- Available pre-filled with boric acid (0.4g) for the preservation of urine samples
- Aseptically manufactured under cleanroom conditions (class 7 ISO 14644) to exclude microbiological contamination
- Manufactured from virgin polystyrene. All materials are non-cytotoxic



Product Code	Description	Capacity (ml)	Label	Materials Base/Cap	Sterility	Case Qty
128A	Container	30	No	PS/PP	AS	400
128B	Container	30	Printed	PS/PP	AS	400
128C	Container	30	Plain	PS/PP	AS	400
128BBAC	Container + boric acid	30	Printed	PS/PP	AS	400

 See the Technical Information section, page 86 for further information on the European directive 98/79/EC

 For disposable glass universals, please see page 20





## Containers, Polystyrene, 30ml Universal + Spoon



- Screw cap with integral spoon - ideal for faecal sampling
- CE marked in accordance with the European Directive 98/79/EC
- For in vitro use only
- Unique leak tight cap ensures excellent sample containment. Leak tested in accordance with EN14254 Annexe D and BS5213
- Aseptically manufactured under cleanroom conditions (class 7 ISO 14644) to exclude microbiological contamination
- Manufactured from virgin polystyrene. All materials are non-cytotoxic

Product Code	Description	Capacity (ml)	Label	Materials Base/Cap	Sterility	Case Qty
128SA	Container + spoon	30	No	PS/PP	AS	400
128SB	Container + spoon	30	Printed	PS/PP	AS	400
128SBB	Container, blue + spoon	30	Printed	PS/PP	AS	400
128SC	Container + spoon	30	Plain	PS/PP	AS	400

## Containers, Polystyrene, 60ml, 100ml, 150ml, 250ml

- Ideal for sample containment
- CE marked in accordance with the European Directive 98/79/EC
- For in vitro use only
- Choice of plastic or metal flow seal cap. Leak tested in accordance with EN14254 Annexe D and BS5213
- Aseptically manufactured under cleanroom conditions (class 7 ISO 14644) to exclude microbiological contamination
- Manufactured from virgin polystyrene. All materials are non-cytotoxic



## Containers, Polystyrene 60ml



Product Code	Description	Capacity (ml)	Label	Materials Base/Cap	Sterility	Case Qty
125AM	Container, metal cap	60	No	PS/ME	AS	300
125BM	Container, metal cap	60	Printed	PS/ME	AS	300
125CM	Container, metal cap	60	Plain	PS/ME	AS	300
125AP	Container, plastic cap	60	No	PS/PE	AS	300
125BP	Container, plastic cap	60	Printed	PS/PE	AS	300
125CP	Container, plastic cap	60	Plain	PS/PE	AS	300



For details of container dimensions, please see page 88 of the Technical Information section.

# containers - disposable polystyrene



## Containers, Polystyrene, 100ml



Product Code	Description	Capacity (ml)	Label	Materials Base/Cap	Sterility	Case Qty
185AM	Container, metal cap	100	No	PS/ME	AS	200
185BM	Container, metal cap	100	Printed	PS/ME	AS	200
185CM	Container, metal cap	100	Plain	PS/ME	AS	200
185AP	Container, plastic cap	100	No	PS/PE	AS	200
185BP	Container, plastic cap	100	Printed	PS/PE	AS	200
185CP	Container, plastic cap	100	Plain	PS/PE	AS	200



## Containers, Polystyrene, 150ml



Product Code	Description	Capacity (ml)	Label	Materials Base/Cap	Sterility	Case Qty
165A	Container, metal cap	150	No	PS/ME	AS	120
165B	Container, metal cap	150	Printed	PS/ME	AS	120
165C	Container, metal cap	150	Plain	PS/ME	AS	120



## Containers, Polystyrene, 250ml



Product Code	Description	Capacity (ml)	Label	Materials Base/Cap	Sterility	Case Qty
190A	Container, metal cap	250	No	PS/ME	AS	50
190B	Container, metal cap	250	Printed	PS/ME	AS	50
190C	Container, metal cap	250	Plain	PS/ME	AS	50



**i** Sterilin® polystyrene containers are also available:  
 - Gamma irradiated  
 - Tray packed

Please contact our customer service department for further details







## Container, Polystyrene, Mucus Extractor



- For obtaining a mucus specimen for microbiological examination. Also suitable for the aspiration of secretions from oropharynx in newborn babies to assist trouble free respiration
- CE marked in accordance with the European Directive 93/42/EC for medical devices
- Suction tube length of 202mm
- Manufactured from materials suitable for medical use
- Leak free cap is included to enable safe transportation to the laboratory for analysis or for safe disposal
- Supplied sterile by gamma irradiation in individual peel pouch
- Lot number and expiry date on each individual pouch ensures complete traceability
- Funnel shaped adapter at the proximal end of suction tube for simple and secured connection

Product Code	Description	Capacity (ml)	Label	Sterility	Case Qty
MP52	Mucus extractor	30	Printed	IRR	100



## Containers, Polystyrene, Non-Pyrogenic



- Suitable for the storage of samples, formulation work, sterility testing and endotoxin testing
- Certified endotoxin free to levels below 0.01EU/ml (Limulus Amoebocyte Lysate (LAL) test)
- In vitro use only
- Supplied sterile by gamma irradiation
- Leak tested in accordance with EN14254 Annexe D and BS5213
- Lot number on each container label and test certificate supplied for each lot

Product Code	Description	Capacity (ml)	Label	Materials Base/Cap	Sterility	Case Qty
129PYR	Container, Non-Pyrogenic	7	Printed	PS/PE	IRR	700
128PYR	Container, Non-Pyrogenic	30	Printed	PS/PP	IRR	400
125PYR	Container, Non-Pyrogenic	60	Printed	PS/ME	IRR	300
185PYR	Container, Non-Pyrogenic	100	Printed	PS/ME	IRR	200
165PYR	Container, Non-Pyrogenic	150	Printed	PS/ME	IRR	120
190PYR	Container, Non-Pyrogenic	250	Printed	PS/ME	IRR	50



The test procedure is validated in accordance with the EU, USP and USFDA guidelines where the principal aim is to demonstrate that the product or the sample does not inhibit or enhance the LAL reaction





## Containers, Polystyrene, Double-Bagged CE

- Ideal for use in hospital theatres to facilitate a sterile transfer of product
- Each container is double wrapped with two 'easy tear' bags
- In vitro use only
- Gamma irradiated with an irradiation dot on each unit to ensure complete sterility
- CE marking denotes compliance with the European Directive 98/79/EC

Product Code	Description	Capacity (ml)	Label	Material Base/Cap	Sterility	Case Qty
128DB/IRR	Container, double bagged	30	Printed	PS/PP	IRR	150
185DB/IRR	Container, double bagged	100	Printed	PS/PE	IRR	80
190DB/IRR	Container, double bagged	250	Printed	PS/ME	IRR	40



### Method of use;



1. Each container is supplied double wrapped and irradiated. An irradiation dot is affixed to each inner bag confirming complete sterility



2. The outer bag can be opened in the non-sterile environment by carefully tearing along the line as directed. The inner bag can easily be pulled from the outer bag by staff within the sterile operating area ensuring a 'sterile' transfer from one area to the next.



3. The container can then be removed from the second bag within the sterile operating environment



# containers - disposable polypropylene

## Containers, Polypropylene, Screw Cap

- Designed specifically for sampling within the food and industrial laboratories.
- Manufactured from shatterproof polypropylene for maximum safety
- Available in a range of colour combinations for ease of identification
- Will surface when dropped into aqueous solutions
- Deep threaded cap to ensure sample containment
- Extensive range from 30ml to 250ml
- Aseptically manufactured



## Containers, Polypropylene, 30ml

Product Code	Description	Capacity (ml)	Label	Colour Base/Cap	Materials Base/Cap	Sterility	Case Qty
LXP30L	Container	30	Printed	Clear/White	PP/PP	AS	1000
LXP30LB	Container	30	Printed	Clear/Blue	PP/PP	AS	1000



## Containers, Polypropylene, 40ml

Product Code	Description	Capacity (ml)	Label	Colour Base/Cap	Materials Base/Cap	Sterility	Case Qty
LXP40	Container	40	None	Clear/White	PP/PE	AS	1000
LXP40L	Container	40	Plain	Clear/White	PP/PE	AS	1000
LXP40LB	Container	40	Plain	Clear/Blue	PP/PE	AS	1000
LXPB40	Container	40	None	Blue/Blue	PP/PE	AS	1000





## Containers, Polypropylene, 60ml

Product Code	Description	Capacity (ml)	Label	Colour Base/Cap	Materials Base/Cap	Sterilit	Case Qty
LXP60	Container	60	None	Clear/White	PP/PE	AS	700
LXP60L	Container	60	Plain	Clear/White	PP/PE	AS	700
LXP60R	Container	60	None	Clear/Red	PP/PE	AS	700
LXP60LR	Container	60	Plain	Clear/Red	PP/PE	AS	700
LXPB60	Container	60	None	Blue/Blue	PP/PE	AS	700
LXPB60L	Container	60	Plain	Blue/Blue	PP/PE	AS	700
LXPR60L	Container	60	Plain	Red/Red	PP/PE	AS	700



## Containers, Polypropylene, 125ml

Product Code	Description	Capacity (ml)	Label	Colour Base/Cap	Materials Base/Cap	Sterility	Case Qty
LXP125	Container	125	None	Clear/White	PP/PE	AS	380
LXP125L	Container	125	Plain	Clear/White	PP/PE	AS	380
LXP125R	Container	125	None	Clear/Red	PP/PE	AS	380
LXP125B	Container	125	None	Clear/Blue	PP/PE	AS	380
LXP125LB	Container	125	Plain	Clear/Blue	PP/PE	AS	380
LXPR125	Container	125	None	Red/Red	PP/PE	AS	380
LXPB125L	Container	125	Plain	Blue/Blue	PP/PE	AS	380



## Containers, Polypropylene, 180ml

Product Code	Description	Capacity (ml)	Label	Colour Base/Cap	Materials Base/Cap	Sterility	Case Qty
LXP180	Container	180	None	Clear/White	PP/PE	AS	264
LXP180L	Container	180	Plain	Clear/White	PP/PE	AS	264
LXP180R	Container	180	None	Clear/Red	PP/PE	AS	264
LXP180LR	Container	180	Plain	Clear/Red	PP/PE	AS	264
LXP180LB	Container	180	Plain	Clear/Blue	PP/PE	AS	264
LXPB180	Container	180	None	Blue/Blue	PP/PE	AS	264
LXPB180L	Container	180	Plain	Blue/Blue	PP/PE	AS	264
LXPR180L	Container	180	Plain	Red/Red	PP/PE	AS	264





## Container, Polypropylene, 250ml

Product Code	Description	Capacity (ml)	Label	Colour Base/Cap	Materials Base/Cap	Sterility	Case Qty
193A	Container, metal cap	250	None	Natural	PP/ME	AS	50



## Containers, Polypropylene, Hinged Lid

- Ideal for industrial sample collection, transport, storage and analysis
- Hinged lid for convenient handling – designed to stay vertical when opened
- Aseptically manufactured
- Shatter-proof polypropylene, offering maximum safety for food industry applications
- Available in natural and the food industry standard of blue
- Autoclavable at 121°C with lid open
- Frosted writing area for sample identification
- Will surface if dropped into a vat of aqueous liquid
- Graduation marks for volume estimation:
  - 45ml container – graduation mark at 40ml
  - 50ml container – graduations every 10ml to 50ml
  - 90ml container – graduation mark at 80ml
  - 300ml container – graduations every 25ml to 275ml and 1oz graduations to 9oz

Product Code	Description	Capacity (ml)	Colour	Material	Sterility	Case Qty
52FLS	Container, hinged lid	45	Natural	PP	AS	650
52FLPLS	Container, hinged lid	45	Blue	PP	AS	650
60FLS	Container, hinged lid	50	Natural	PP	AS	650
60FLPLS	Container, hinged lid	50	Blue	PP	AS	650
100FLS	Container, hinged lid	90	Natural	PP	AS	350
100FLPLS	Container, hinged lid	90	Blue	PP	AS	350
300FLS	Container, hinged lid	300	Natural	PP	AS	240
300FLPLS	Container, hinged lid	300	Blue	PP	AS	240



## Containers, Polypropylene, Snap Cap

- Ideal for sampling applications in industrial laboratories
- Manufactured from shatter-proof polypropylene - offers maximum safety for food industry applications
- Conical profile enables stacking
- Available either sterile or non-sterile
- Will surface if dropped into a vat of aqueous liquid
- Graduation marks for volume estimation:
  - 200ml container – 25ml graduations to 200ml
  - 400ml container – 50ml graduations to 400ml
  - 960ml container – 100ml graduations to 1000ml



Product Code	Description	Capacity (ml)	Overall Height (mm)	Materials Base/Cap	Sterility	Case Qty
200PPN	Container only	200	87	PP	NS	660
201PPN	Container, cap, unassembled	200	87	PP/PE	NS	660
202PPI	Container, cap, assembled	200	88	PP/PE	IRR	220
400PPN	Container only	400	100	PP	NS	460
401PPN	Container, cap, unassembled	400	100	PP/PE	NS	460
402PPI	Container, cap, assembled	400	101	PP/PE	IRR	185
1000PPN	Container only	960	130	PP	NS	250
1001PPN	Container, cap, unassembled	960	130	PP/PE	NS	250
1002PPI	Container, cap, assembled	960	131	PP/PE	IRR	80



## Container, Glass, 7ml Bijou

- Ideal for small volume samples
- Glass construction offers superior chemical resistance
- Tray packed for safety and convenience
- For in vitro use only

Product Code	Description	Capacity (ml)	Label	Material Base/Cap	Sterility	Case Qty
39503T	Glass Container	7	No	G/PP	NS	360



## Container, Glass, 30ml Universal

- Ideal for applications where there is a requirement for high chemical resistance
- Tray packed for safety and convenience
- For in vitro use only

Product Code	Description	Capacity (ml)	Label	Material Base/Cap	Sterility	Case Qty
UC/30	Glass container	30	No	G/PP	NS	500

**i** Please note that the above glassware is manufactured from Soda glass and therefore it is recommended that the product is not autoclaved



## Cap, Glass, 28ml Universal

- Can be used as replacement caps when autoclaving
- Manufactured from polypropylene using cadmium free white colouring
- Fits glass universal

Product Code	Description	Sterility	Case Qty
R328	28mm cap for glass universal	NS	2,850



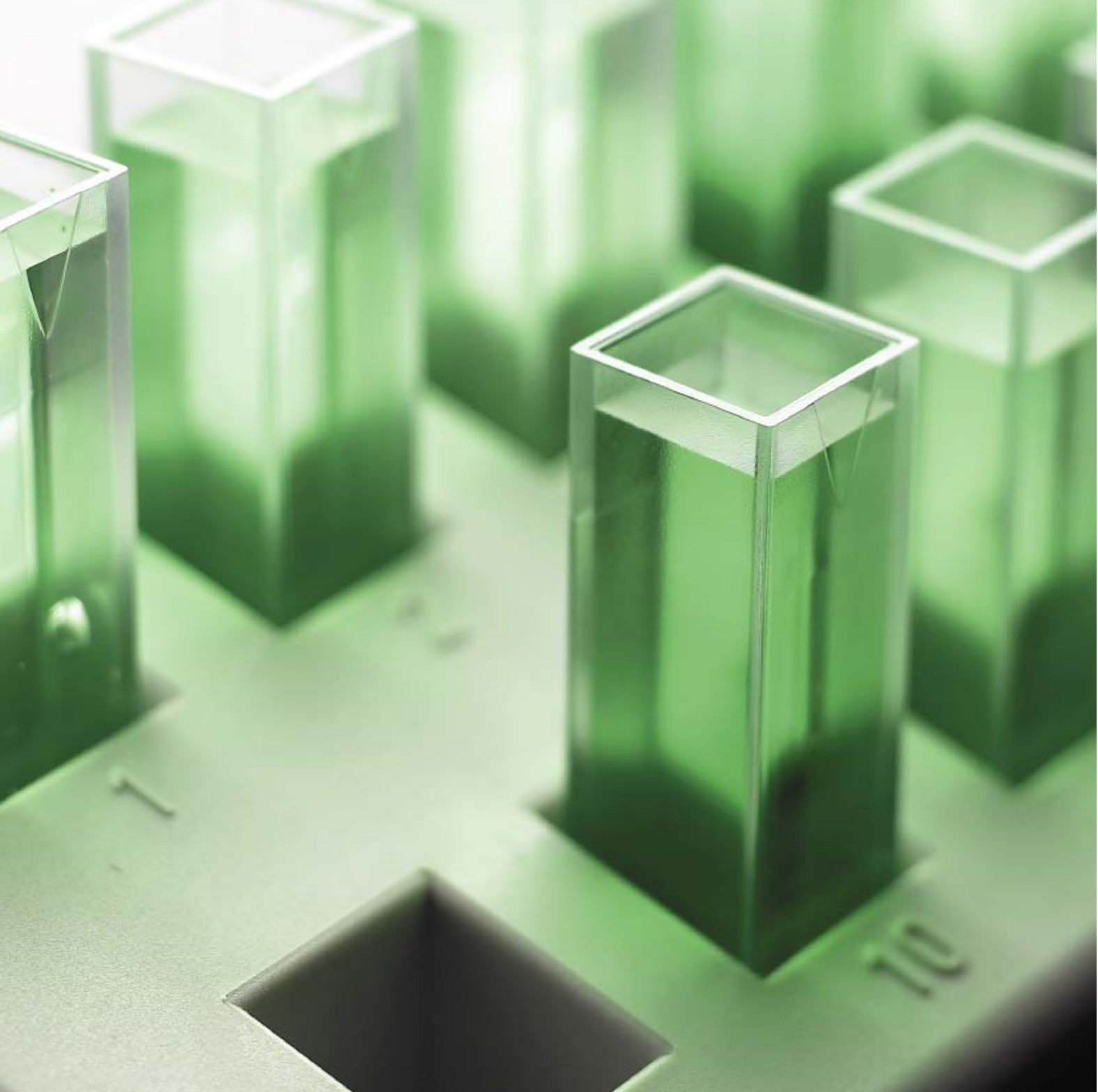

# Cuvettes



## Cuvettes

- Suitable for use with most spectrophotometers for water analysis, chemistry and life science applications
- Choice of material:
  - Optical quality polystyrene for use at visible wavelengths (340 to 900nm)
  - Optical quality acrylic (PMMA) for use at ultra violet wavelengths (300 to 900nm)
- Each case contains cuvettes from the same mould cavity to ensure minimal dimensional variation. Standard absorption variation between cuvettes is better than +/- 0.005 absorbency units
- Two sizes available - semi-micro cuvette and macro cuvette
- Standard path length of 10mm
- Frosted sides on the cuvette provide an ideal labelling and handling area
- Recessed windows reduce the risk of scratching during use
- For ease of use an arrow feature indicates the direction of light transmission
- Packed in expanded polystyrene (EPS) foam trays for optimum protection ensuring scratch free product at the time of use

Product Code	Description	Capacity (ml)	Window Width x Height (mm)	Material	Sterility	Inner Pack Qty	Case Qty
221M	Macro cuvette	2.5 - 4.5	10 x 32.5	PS	NS	100	500
221S	Semi-micro cuvette	1.5 - 3.0	4.5 x 22	PS	NS	100	500
222M	Macro cuvette	2.5 - 4.5	10 x 32.5	PMMA	NS	100	500
222S	Semi-micro cuvette	1.5 - 3.0	4.5 x 22	PMMA	NS	100	500

**i** For more information on the definition of 'cuvettes from the same mould cavity' and the chemical resistance of the cuvettes, refer to page 89 of the Technica Information Section.



## Cuvette Rack

- Facilitates the handling and preparation of cuvettes
- Holds 20 cuvettes in numbered positions
- Manufactured from polypropylene to withstand sterilisation

Product Code	Description	Material	Sterility	Inner Pack Qty	Case Qty
220R	Cuvette Rack	PP	NS	1	1

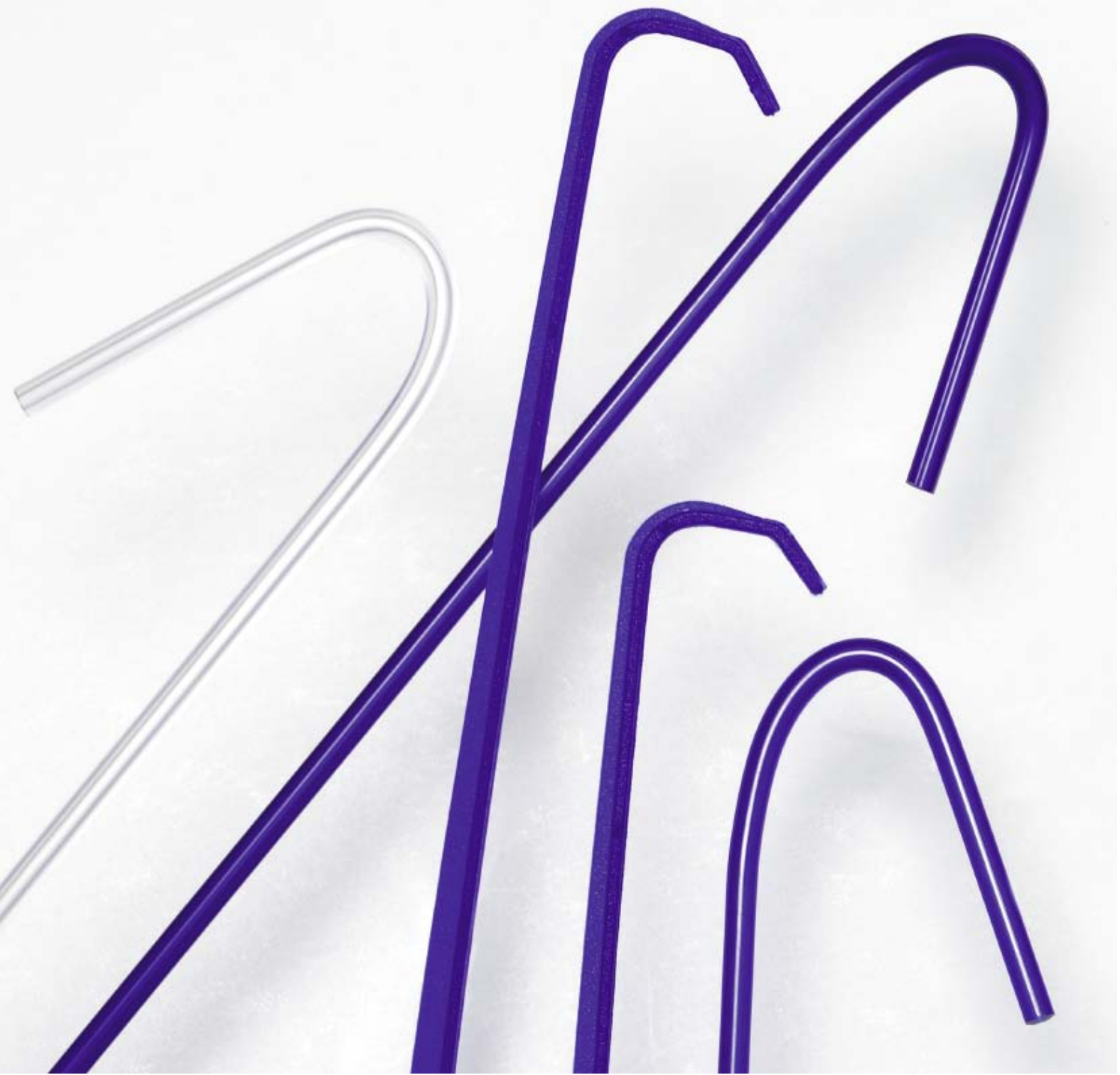

# Dippers



## Dippas®, Polystyrene

- Facilitates sample collection and subsequent transportation to the laboratory in a single container, with no risk of cross contamination
- Handle neatly snaps off after sample collection for ease of transportation
- Individually wrapped and gamma irradiated to ensure sterility
- Supplied with a 'flow-seal' screw cap, tested in accordance with EN 14254 Annex D and BS5213 for a leak tight seal
- Available in either clear polystyrene or in the food industry standard of blue
- A choice of handle length to accommodate the majority of sampling applications

Product Code	Description	Capacity (ml)	Colour	Handle Length (mm)	Material Base/Cap	Sterility	Case Qty
191	Dippa, screw cap	30	Clear	191	PS/PP	IRR	50
191BLUE	Dippa, screw cap	30	Blue	191	PS/PP	IRR	50
194IW	Dippa, screw cap	100	Clear	383	PS/ME	IRR	100
194IWBLUE	Dippa, screw cap	100	Blue	383	PS/ME	IRR	100
192	Dippa, screw cap	250	Clear	334	PS/ME	IRR	50
192BLUE	Dippa, screw cap	250	Blue	334	PS/ME	IRR	50



## Dippers, Polypropylene

- For the sterile collection and transportation without the risk of contamination
- Manufactured from shatterproof polypropylene
- Individually wrapped and gamma irradiated to ensure sterility
- Handles are detachable after sample has been collected
- Choice of screw-cap or hinged lid

Product Code	Description	Capacity (ml)	Colour	Handle Length (mm)	Material Base/Cap	Sterility	Case Qty
195PPD	Dipper, screw cap	40	Blue	220	PP/PE	IRR	250
200PPD	Dipper, hinged cap	45	Blue	220	PP/PP	IRR	250
205PPD	Dipper, hinged cap	90	Blue	220	PP/PP	IRR	150
210PPD	Dipper, screw cap	125	Blue	220	PP/PE	IRR	100
215PPD	Dipper, screw cap	180	Blue	220	PP/PE	IRR	100





# Jars



## Jars, Screw Cap, Non Sterile



- Multi-use disposable jars – ideal for liquid, solid, food and histology samples
- Wide neck enables bulk, one piece specimens to be stored easily
- Suitable for direct transfer of specimen from patient to jar
- Plastic wadded cap
- CE marked in accordance with the European Directive 98/79/EC

Product Code	Description	Capacity (ml)	Label	O.H. x O.D. (mm)	Material Jar/Cap	Sterility	Case Qty
28308	Jar, screw cap	30	None	48 x 35	PS/UREA	NS	200
28340	Jar, screw cap	60	None	62 x 43	PS/UREA	NS	200
28381	Jar, screw cap	120	None	72 x 54	PS/UREA	NS	100
28423	Jar, screw cap	230	None	82 x 69	PS/UREA	NS	100
28464	Jar, screw cap	350	None	90 x 80	PS/UREA	NS	100
28316	Jar, screw cap	30	Printed	48 x 35	PS/UREA	NS	200
28357	Jar, screw cap	60	Printed	62 x 43	PS/UREA	NS	200
28399	Jar, screw cap	120	Printed	72 x 54	PS/UREA	NS	100
28431	Jar, screw cap	230	Printed	82 x 69	PS/UREA	NS	100
28472	Jar, screw cap	350	Printed	90 x 80	PS/UREA	NS	100

## Jars, Screw Cap, Sterile



- Multi-use disposable jars – ideal for liquid, solid, food and histology samples
- Sterilised by gamma irradiation
- Wide neck enables bulk, one piece specimens to be stored easily
- Suitable for direct transfer of specimen from patient to jar
- Plastic wadded cap
- CE marked in accordance with the European Directive 98/79/EC

Product Code	Description	Capacity (ml)	Label	O.H. x O.D. (mm)	Material Jar/Cap	Sterility	Case Qty
28324	Jar, screw cap	30	None	48 x 35	PS/UREA	IRR	200
28365	Jar, screw cap	60	None	62 x 43	PS/UREA	IRR	200
28407	Jar, screw cap	120	None	72 x 54	PS/UREA	IRR	100
28449	Jar, screw cap	230	None	82 x 69	PS/UREA	IRR	100
28480	Jar, screw cap	350	None	90 x 80	PS/UREA	IRR	100
28332	Jar, screw cap	30	Printed	48 x 35	PS/UREA	IRR	200
28373	Jar, screw cap	60	Printed	62 x 43	PS/UREA	IRR	200
28415	Jar, screw cap	120	Printed	72 x 54	PS/UREA	IRR	100
28456	Jar, screw cap	230	Printed	82 x 69	PS/UREA	IRR	100
28498	Jar, screw cap	350	Printed	90 x 80	PS/UREA	IRR	100



## Inoculating loops, needles and spreaders





## Loops, Inoculating with needle

- For dilution streaking and obtaining isolated colonies
- Features a fixed volume loop at one end and a needle for colony extraction at the other
- Accuracy of +/- 20% certified using Evans Blue Dye Method. Certificate of calibration in every case
- No rough edges on the loop head means smooth, problem free plating and streaking of cultures
- Choice of rigid or flexible loops to suit different applications and user preferences.
- Free of lubricants, oils and electrostatic charges to facilitate consistent wetting and complete liquid transfer
- Hexagonal shaft improves grip and assists orientation

Product Code	Description	Volume (µl)	Colour	Sterility	Inner Pack Qty	Case Qty
SL1H	Inoculating loop, hard	1	Dark green	IRR	10	800
SL1S	Inoculating loop, soft	1	Pale green	IRR	10	800
SL10H	Inoculating loop, hard	10	Dark blue	IRR	10	800
SL10S	Inoculating loop, soft	10	Pale blue	IRR	10	800



## Loops, Inoculating with sphere

- Used in microbiological applications for dilution streaking and obtaining isolated colonies
- Inoculation loop for fixed sample volumes at one end and sphere for streaking at the other
- By turning the square handle 90° after each streaking, the sphere provides up to four sterile streaking surfaces
- Eliminates the need for flaming and subsequent risk of aerosols

Product Code	Description	Volume (µl)	Colour	Sterility	Inner Pack Qty	Case Qty
QL1	Inoculating loop with sphere	1	Green	IRR	20	1000
QL10	Inoculating loop with sphere	10	Blue	IRR	20	1000



## Needles

- Ideal for picking off individual colonies within mixed cultures growing on plated media
- Suitable for making stab inoculations into agar slants or tubes of solid culture media

Product Code	Description	Colour	Length (mm)	Sterility	Inner Pack Qty	Case Qty
SN20	Inoculation needle	Violet	198	IRR	20	1000



## Spreaders

- Designed for spreading and dispersing liquids across the surface of agar culture plates
- L-shaped with smooth rounded surfaces to prevent gouging of agar during inoculation

Product Code	Description	Colour	Sterility	Inner Pack Qty	Case Qty
SPCS01	L-shaped spreader	Blue	IRR	1	500
SPCS05	L-shaped spreader	Blue	IRR	5	1000



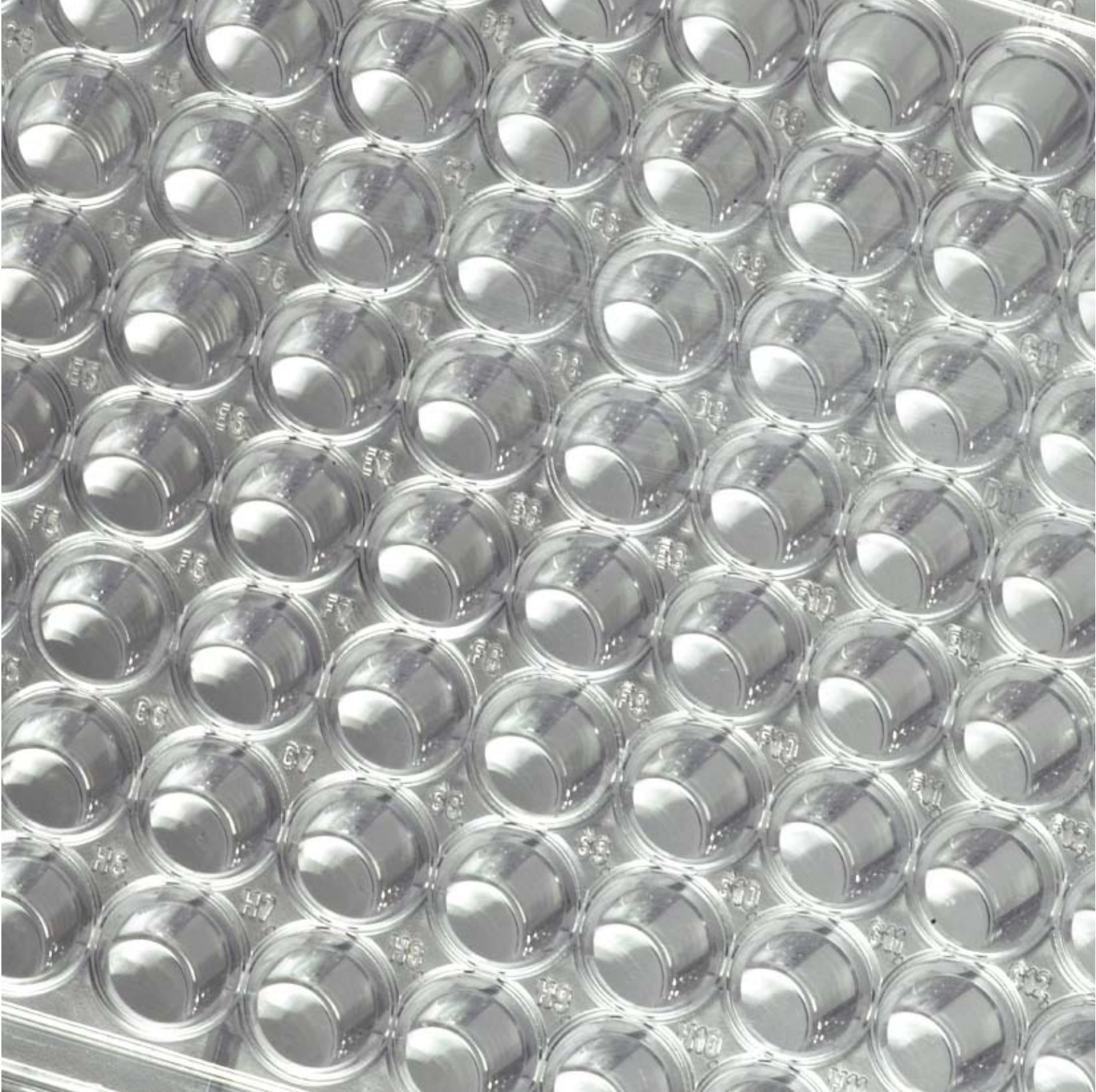

# Microtitre Plates



## Microtitre Plates, Clear

- Used for serology work, microbiology screening, EIA/absorbance assays, sample storage and transport
- Manufactured from virgin polystyrene giving excellent optical clarity
- No surface treatment, thus providing a low binding surface
- CE marked in accordance with European Directive 98/79/EC
- Compatible with automated plate readers and washers
- Suitable for use at a wavelength of 340nm
- Condensation rings on the lid, together with raised well rims on the base, help minimise the risk of contamination from surrounding wells
- Orientation corners and alpha numeric labelling ensure easy sample identification
- Frosted write-on area on end wall of plate for clear identification
- Hanging well design ensures even temperature distribution around each well

Product Code	Description	Well Capacity (µl)	Lid	Material	Sterility Pack Qty	Inner Qty	Case Qty
611U96	96 well plate, U bottom	330	No	PS	NS5	5	50
611V96	96 well plate, V bottom	310	No	PS	NS	5	50
611F96	96 well plate, Flat bottom	400	No	PS	NS	5	50
612U96	96 well plate, U bottom, sterile	330	No	PS	IRR	1	50
612V96	96 well plate, V bottom, sterile	310	No	PS	IRR	1	50
612F96	96 well plate, Flat bottom, sterile	400	No	PS	IRR	1	50
642000	Lid for microtitre plate	-	Yes	PS	IRR	1	50

Multiwell plates for tissue culture applications can be found on page 78

Information on the CE directive can be found on page 86 of the Technical Information section



## Microtitre Plates, Black

- Ideal for fluorescence work where the black pigment prevents 'cross-talk' between the wells
- Low background fluorescence minimises light scattering
- No surface treatment, thus providing a medium binding surface
- Chimney well design to help reduce contamination

Product Code	Description	Well Capacity (µl)	Lid	Material	Sterility Pack Qty	Inner Qty	Case Qty
611F96BK	Black 96 well plate, Flat bottom	400	No	PS	NS	5	50

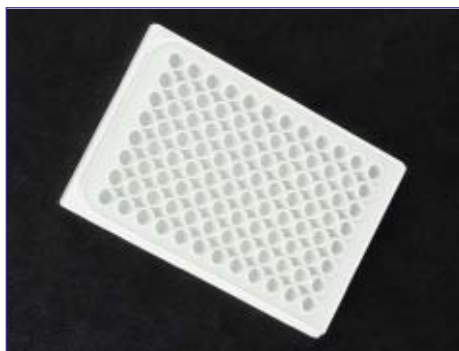

## Microtitre Plates, White

- Ideal for bioluminescence studies where the white pigment aid reflectivity and sensitivity and prevents well to well cross-talk
- No surface treatment, thus providing a medium binding surface
- Chimney well design to help reduce contamination

Product Code	Description	Well Capacity (µl)	Lid	Material	Sterility Pack Qty	Inner Qty	Case Qty
611F96WT	White 96 well plate, Flat bottom	400	No	PS	NS	5	50

For details on selecting the correct type of plate for your application refer to page 90 the Technical Information section





# Petri Dishes



# petri dishes

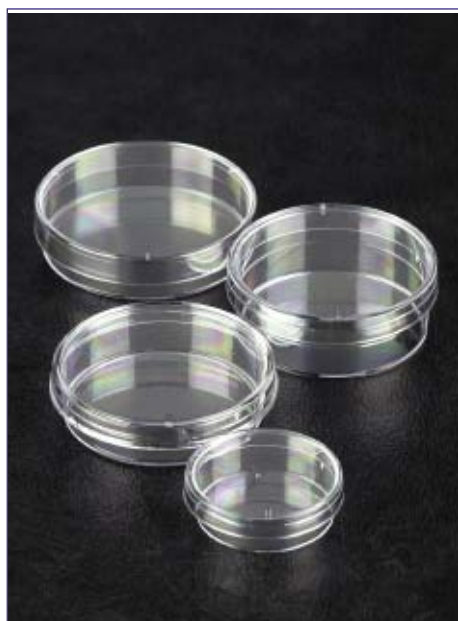

## Petri Dishes, 30mm, 50mm, 55mm, 60mm

- Ideal for use when savings in media or incubator space are required
- 55mm dish accommodates 47mm membrane filters making it suitable for water testing
- 50mm deep form dish (product code 124) is over 20mm deep and designed for use with liquid media
- Aseptically manufactured under clean room conditions (class 7 ISO14644) to exclude microbiological contamination

Product Code	Description	Vents	Sterility	Base OD x OH (mm)	Inner Pack (mm)	Case Qty
121V	Petri dish, 30mm	Triple	AS	35 x 11	10	800
122	Petri dish, 50mm	Single	AS	52 x 14.5	10	700
124	Petri dish, 50mm, deep form	Single	AS	50 x 20.3	20	500
PF55	Petri dish, 55mm	None	AS	55.5 x 12	15	1620
PF55V	Petri dish, 55mm	Triple	AS	55.5 x 12	15	1620
123	Petri dish, 60mm	Single	AS	60 x 15.1	10	540





## Petri Dishes, 90mm, Standard



- Used by microbiologists to culture micro-organisms on solid media
- Available either:
  - Aseptically manufactured under clean room conditions (class 7 ISO14644) to exclude microbiological contamination
  - Terminally sterilised by gamma irradiation
- CE marked in accordance with European Directive 98/79/EC
- In vitro use only
- Produced and tested in accordance with the BS611 part 2 standard, which includes stringent dimensional controls
- Ideal for use in automatic plate pourers
- Available in single, triple and non-vented formats
  - Triple vented - aids gaseous exchange. Ideally suited for short term work
  - Single vented - limits gaseous exchange, minimises evaporation and dehydration. Ideally suited for long term work
  - Non-vented - most suitable for anaerobic and long term work
- Manufactured from virgin polystyrene
- Mirror finished moulds ensure high optical clarity

Product Code	Description	Vents	Sterility	Base OD x OH (mm)	Inner Pack Qty	Case Qty
101R20	Petri dish, 90 mm	Single	AS	89.25 x 16.0	20	500
101/IRR	Petri dish, 90 mm	Single	IRR	89.25 x 16.0	20	500
101VR20	Petri dish, 90 mm	Triple	AS	89.25 x 16.2	20	500
101V/IRR	Petri dish, 90 mm	Triple	IRR	89.25 x 16.2	20	500
101RT	Petri dish, 90 mm	None	AS	89.25 x 15.8	20	500
101RT/IRR	Petri dish, 90 mm	None	IRR	89.25 x 15.8	20	500

 Training aids for teaching essential microbiology techniques are detailed on page 36

 See Technical Information section; page 91 for information on aseptic manufacture page 90 for information on the BS611 part 2 standard





## Petri Dishes, 90mm, Triple Bagged



- Ideal for use in dedicated areas where the sterile transfer of product is essential
- In vitro use only
- Innermost bag carries an irradiation dot to confirm sterility and batch number to ensure traceability
- Batch specific certificate inside each carton

Product Code	Description	Vents	Sterility	Base OD x OH (mm)	Inner Pack Qty	Case Qty
101VR05TB	Petri dish, 90mm	Triple	IRR	89.25 x 16.2	5	375
101VR18TB	Petri dish, 90mm	Triple	IRR	89.25 x 16.2	18	450
501VTB	Petri dish, 140mm	Triple	IRR	138.9 x 21.1	9	72

**i** Note that this range is manufactured to order and minimum order quantities apply

Please contact our customer service department for details



## Petri Dishes, 90mm, Coloured

- Aids ease of identification, especially suitable for identification of group work within teaching laboratories
- Aseptically manufactured under clean room conditions (class 7 ISO14644) to exclude microbiological contamination
- Manufactured using cadmium free non-cytotoxic colourants
- In vitro use only
- Produced and tested in accordance with the BS611 part 2 standard

Product Code	Description	Colour	Vents	Sterility	Base OD x OH (mm)	Inner Pack Qty	Case Qty
101VAMB	Petri dish, 90mm	Amber	Triple	AS	89.25 x 16.2	20	500
101VBLUE	Petri dish, 90mm	Blue	Triple	AS	89.25 x 16.2	20	500
101VRED	Petri dish, 90mm	Red	Triple	AS	89.25 x 16.2	20	500



## Petri Dishes, 90mm, Compartmented



- Ideal for use with different media or when savings in media / incubator space are required
- Aseptically manufactured under clean room conditions (class 7 ISO14644) to exclude microbiological contamination
- CE marked in accordance with the European Directive 98/79/EC
- In vitro use only
- Manufactured to BS 611 part 2
- Single frosted locator mark where division meets outer wall

Product Code	Description	Compartments	Vents	Sterility	Base OD x OH (mm)	Inner Pack Qty	Case Qty
502VF	Petri dish, 90mm	2	Triple	AS	89.25 x 16.2	20	500
503VF	Petri dish, 90mm	3	Triple	AS	89.25 x 16.2	20	500





## Petri Dish, 140mm



- Ideal for applications where a large surface area and very flat base are required
- Easy grip ridges on the base to aid individual dish handling
- Aseptically manufactured under clean room conditions (class 7 ISO14644) to exclude microbiological contamination
- Produced and tested in accordance with the BS611 part 2 standard, which includes stringent dimensional controls
- Ideal for use in automatic plate pourers

Product Code	Description	Vents	Sterility	Base OD x OH (mm)	Inner Pack Qty	Case Qty
501V	Petri dish, 140mm	Triple	AS	138.9 x 21.1	10	80

## Petri Dishes, 100mm, Square



- Non compartmentalised dish is ideal for antibiotic sensitivity testing, when a large surface area and very flat base is required
- Compartmentalised dish is ideal for small volume liquid media work or for sample storage
  - the 25 compartments each have a surface area of 1.8cm<sup>2</sup> and capacity of 5ml
  - the lid features selectable venting or non-venting positions \*
- Aseptically manufactured under clean room conditions (class 7 ISO14644) to exclude microbiological contamination

Product Code	Description	Vents	Sterility	Base OD x OH (mm)	Inner Pack Qty	Case Qty
109	Petri dish, 100mm	None	AS	101.6 x 21.1	4	120
103	Petri dish, 100mm, 25 compartment	*	AS	101.0 x 20.8	4	120

\* Lid turns through 90° to allow for venting or non-venting of the dish



## Petri Dish, 55mm, Contact Plate

- Ideal for use in routine hygiene monitoring of surfaces
- Concave profile of the dish raises the profile of the media when set giving better contact between the agar bed and surface under test
- 25cm<sup>2</sup> surface area – conforms to both the Institute of Environmental Sciences (IES, 1993) and the International Pharmaceutical Federation (I.P.F., 1990) Standards
- Aseptically manufactured under clean room conditions (class 7 ISO14644) to exclude microbiological contamination
- Triple vented – aids gaseous exchange
- Numbered grid on the base – facilitates colony counting
- Deep skirted base – aids stability when stacked

Product Code	Description	Vents	Sterility	Base OD x OH (mm)	Inner Pack Qty	Case Qty
504	Contact Plate, 55mm	Triple	AS	67 x 10.4	10	300



 All Sterilin® petri dishes are also available terminally sterilised by gamma irradiation.

Please contact our customer service department for further details

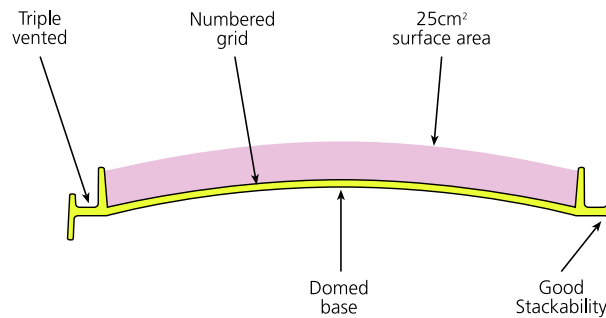



## Microbiological Training Aid



Guide-Plate 1

- Invaluable training aid for new entrants into the microbiology laboratory
- Ensures consistency and good quality laboratory practice
- Consists of two re-usable templates:
  - Guide-Plate 1 - used to help achieve consistency of volumes of agar poured into Petri dishes
  - Guide-Plate 2 - ideal for teaching and improving streaking and spreading techniques.
  - A clear traceable five-point streak pattern enables single colony isolation
- Complete with comprehensive instruction manual
- Locating grooves around the rim of the G-Plates secures the Petri dish in place during the procedure
- Manufactured from easy to clean polypropylene



Guide-Plate 2

Product Code	Description	Case Qty
G-PLATE	Guide plates (G-Plate 1, G-Plate 2 and instruction manual)	1 Pack



Developed in conjunction with microbiologist Dr Chris Bell  
Only suitable for use with Sterilin 90mm Petri dishes





# Pipettes

## Pipettes, Serological

Sterilin single use, serological pipettes are manufactured using virgin grade polystyrene and to stringent quality specifications. All pipettes in our extensive range carry the following features:

- Gamma irradiated to ensure sterility and certified non-pyrogenic with an endotoxin level of below 0.25EU/ml
- Batch specific certificate supplied in each carton
- Lot number for complete traceability
- Accuracy of +/-1% for nominal volume
- Clear black printed graduations for maximum clarity
- Descending and ascending graduations to aid pipetting
- Negative graduations for extra capacity
- Colour coded for ease of identification

**40101 / 40301 / 40101NP / 40501**

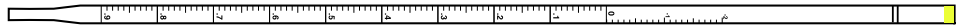

**41301**

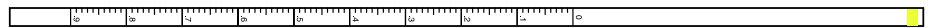

**40102 / 40302 / 40102NP / 40502**



**41302**



**40105 / 40305 / 40105NP**

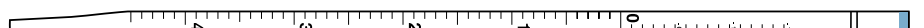

**41305**



**42505**

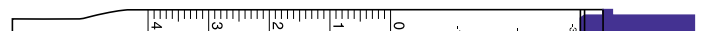

**47105 / 47305 / 47505 / 47105N / 47305N**

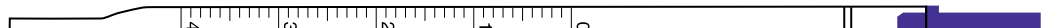

**41310**

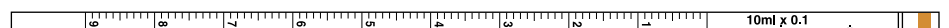

**42510**



**47110 / 47310 / 47510 / 47110N / 47310N**



**40125 / 40125NP / 47525**

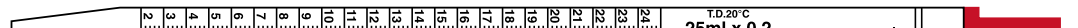

**47150 / 47550**



**43301P**

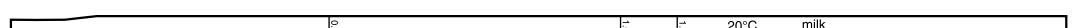

**43302P**

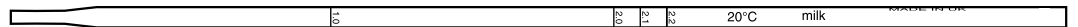

**S28**



**S28BL**





## Pipettes, Bulk Packed, Plugged

- Bulk packed in convenient shelf packs

Product Code	Description	Negative Graduations (ml)	Overall Length (mm)	Sterility	Shelf Pack Qty	Case Qty
40301K	1ml pipette	-0.2	279	IRR	50	1000
40302K	2ml pipette	-0.3	279	IRR	50	1000
47305	5ml pipette	-2.0	298	IRR	25	200
47310	10ml pipette	-3.0	333	IRR	25	500
40305	5ml pipette *	-1.5	275	IRR	25	200

\* Without suction adapter



## Pipettes, Individually Wrapped, Plastic Film Packaging, Plugged

Product Code	Description	Negative Graduations (ml)	Overall Length (mm)	Sterility	Inner Pack Qty	Shelf Pack Qty	Case Qty
40101K	1ml pipette	-0.2	279	IRR	1	100	1000
40102K	2ml pipette	-0.3	279	IRR	1	100	1000
47105	5ml pipette	-2.0	298	IRR	1	50	200
47110	10ml pipette	-3.0	333	IRR	1	50	500
40125	25ml pipette	-10.0	349	IRR	1	25	200
47150	50ml pipette	-5.0	344	IRR	1	50	50
40105	5ml pipette *	-1.5	275	IRR	1	50	200

\* Without suction adapter

 See page 38 for full profile of disposable plastic pipettes



## Pipettes, Individually Wrapped, Plastic Film Packaging, Unplugged

- Ideal for use in aspiration techniques

Product Code	Description	Overall Length (mm)	Sterility	Inner Pack Qty	Shelf Pack Qty	Case Qty
40101NPK	1ml pipette	279	IRR	1	100	1000
40102NPK	2ml pipette	279	IRR	1	100	1000
40105NP	5ml pipette	250	IRR	1	50	200
40125NP	25ml pipette	349	IRR	1	25	200





# pipettes



## Pipettes, Individually Wrapped, Paper Peel Packaging, Plugged

- Printed with product code, lot number and expiry date
- Paper backing allows for easier access
- Paper backing maintains shape for easy disposal of pipette within wrapper following use

Product Code	Description	Negative Graduations (ml)	Overall Length (mm)	Sterility	Inner Pack Qty	Shelf Pack Qty	Case Qty
40501K	1ml pipette	-0.2	279	IRR	1	100	1000
40502K	2ml pipette	-0.3	279	IRR	1	100	1000
47505	5ml pipette	-2.0	275	IRR	1	50	200
47510	10ml pipette	-3.0	333	IRR	1	50	500
47525	25ml pipette	-10.0	349	IRR	1	25	200
47550	50ml pipette	-5.0	344	IRR	1	25	50



## Pipettes, Narrow Orifice, Individually Wrapped, Plastic Film Packaging, Plugged

- For use in cell culture applications
- Special narrow orifice to help shear clumps of cells with repeated aspiration

Product Code	Description	Negative Graduations (ml)	Overall Length (mm)	Sterility	Inner Pack Qty	Shelf Pack Qty	Case Qty
47105N	5ml pipette, narrow orifice	-2.0	275	IRR	1	50	200
47110N	10ml pipette, narrow orifice	-3.0	333	IRR	1	50	500

**i** See page 38 for full profile of disposable plastic pipettes



## Pipettes, Narrow Orifice, Bulk Packed, Plugged

- Bulk packed in shelf packs of 25 pipettes for the busy laboratory
- For use in cell culture
- Special narrow orifice to help shear clumps of cells with repeated aspiration

Product Code	Description	Negative Graduations (ml)	Overall Length (mm)	Sterility	Shelf Pack Qty	Case Qty
47305N	5ml pipette, narrow orifice	-2.0	275	IRR	25	200
47310N	10ml pipette, narrow orifice	-3.0	333	IRR	25	500





## Pipettes, Shortie, Individual Paper Peel Packaging, Plugged

- Short convenient length
- Specifically designed for use in laminar air flow cabinets – easier to manipulate in confined spaces

Product Code	Description	Negative Graduations (ml)	Overall Length (mm)	Sterility	Inner Pack Qty	Shelf Pack Qty	Case Qty
42505	5ml shortie pipette	-3.0	226	IRR	1	50	200
42510	10ml shortie pipette	-10.0	232	IRR	1	50	200

**i** A range of shortie pipettes manufactured in chemically resistant glass can be found on page 43



## Pipettes, Open-ended, Bulk Packed, Plugged

- Wide orifice - for use with viscous liquids
- Ideal in food laboratories for pipetting homogenised samples

Product Code	Description	Negative Graduations (ml)	Overall Length (mm)	Sterility	Shelf Pack Qty	Case Qty
41301K	1ml pipette, open end	-0.2	271	IRR	50	1000
41302K	2ml pipette, open end	-0.3	271	IRR	50	1000
41305	5ml pipette, open end	-2.0	250	IRR	25	200
41310*	10ml pipette, open end	-2.0	350	IRR	25	500

\* Not suitable for use with automatic pipette fillers

**i** See page 38 for full profile of disposable plastic pipettes



## Pipettes, Milk

- Specifically designed for use within the milk industry
- Graduated up to 1.1ml and 2.2ml

Product Code	Description	Overall Length (mm)	Sterility	Shelf Pack Qty	Case Qty
43301PK	1.1ml milk pipette	279	IRR	50	1000
43302PK	2.2ml milk pipette	279	IRR	50	1000





## Pipettes, ESR



- For use in determining Erythrocyte Sedimentation Rates (ESR)
- CE marked in accordance with the European Directive 98/79/EC
- For in vitro use only
- Available with or without printed graduations
- Plugged

Product Code	Description	Overall Length (mm)	Sterility	Shelf Pack Qty	Case Qty
S28	ESR pipette, ungraduated,	229	NS	50	500
S28BL	ESR pipette, graduated,	229	NS	50	500

**i** S28BL is graduated 0 to 190mm



## Pipettes, Serological, Glass, Individual Paper Peel Packaging, Plugged



- Manufactured in chemically resistant Pyrex® borosilicate glass
- Calibrated for delivery with the last drop expelled by blowing
- Easy to read graduations

Product Code	Description	Negative Graduations (ml)	Overall Length (mm)	Sterility	Shelf Pack Qty	Case Qty
7077-1N	1ml pipette	-0.2	290	IRR	1	800
7077-2N	2ml pipette	-0.2	290	IRR	1	720
7077-5N	5ml pipette	-1.0	290	IRR	1	720
7077-10N	10ml pipette	-2.0	290	IRR	1	600



## Pipettes, Serological, Glass, Bulk Packed, Plugged



- Manufactured in chemically resistant Pyrex® borosilicate glass
- Bulk packed in easy to handle shelf packs
- Calibrated for delivery with the last drop expelled by blowing
- Easy to read graduations

Product Code	Description	Negative Graduations (ml)	Overall Length (mm)	Sterility	Shelf Pack Qty	Case Qty
7078-5X	0.5ml pipette	-0.2	215	IRR	25	500
7078-1CN	1ml pipette	-0.2	290	IRR	50	1000
7078-2N	2ml pipette	-0.2	290	IRR	35	700
7078-5N	5ml pipette	-1.0	290	IRR	30	960
7078-10N	10ml pipette	-2.0	290	IRR	20	720



## Pipettes, Serological, Glass, Bulk Packed, Unplugged

**PYREX®**

- Manufactured in chemically resistant Pyrex® borosilicate glass
- Bulk packed in easy to handle shelf packs
- Calibrated for delivery with the last drop expelled by blowing
- Easy to read graduations

Product Code	Description	Negative Graduations (ml)	Overall Length (mm)	Sterility	Shelf Pack Qty	Case Qty
7079-5X	0.5ml pipette	-0.2	215	NS	125	500
7079-1N	1ml pipette	-0.2	290	NS	50	1000
7079-2N	2ml pipette	-0.2	290	NS	35	700
7079-5N	5ml pipette	-1.0	290	NS	30	960
7079-10N	10ml pipette	-2.0	290	NS	30	720



## Pipettes, Serological, Glass, Short, Bulk Packed, Plugged

**PYREX®**

- Manufactured in chemically resistant Pyrex® borosilicate glass
- Compact size, ideal for operation in confined spaces, such as laminar air flow cabinets
- Calibrated for delivery with the last drop expelled by blowing
- Easy to read graduations

Product Code	Description	Negative Graduations (ml)	Overall Length (mm)	Sterility	Shelf Pack Qty	Case Qty
7078B-1	1ml pipette	-0.5	215	IRR	20	500
7078B-5	5ml pipette	-3.0	215	IRR	10	400
7078B-10	10ml pipette	-4.0	215	IRR	10	400
7078B-25	25ml pipette	-5.0	300	IRR	5	400
7078B-50	50ml pipette	-3.0	358	IRR	5	50





# pipettes

## Pipettes, Transfer, Plastic



- Ideal for transferring liquids safely
- Manufactured from non-toxic, low density polyethylene
- Integral filling bulb eliminates contamination associated with separate rubber bulbs
- Excellent transparency and uniform thickness
- Precise graduations on 1ml and 3ml versions ensuring consistent results
- Can be heat sealed for sample storage and transportation
- Heat sealed bulbs suitable for storage in the gas phase of liquid nitrogen

Product Code	Description	Upper Graduation	Sterility	Shelf Pack	Case Qty
201C	Transfer Pipette	1ml	NS	500	3000
PP88SA	Transfer Pipette	1ml	IRR	10	500
PP88SB	Transfer Pipette	1ml	IRR	1	500
200C	Transfer Pipette	3ml	NS	500	3000
PP89SA	Transfer Pipette	3ml	IRR	10	500
PP89SB	Transfer Pipette	3ml	IRR	1	500
202C	Transfer Pipette, narrow stem	None	NS	500	3000

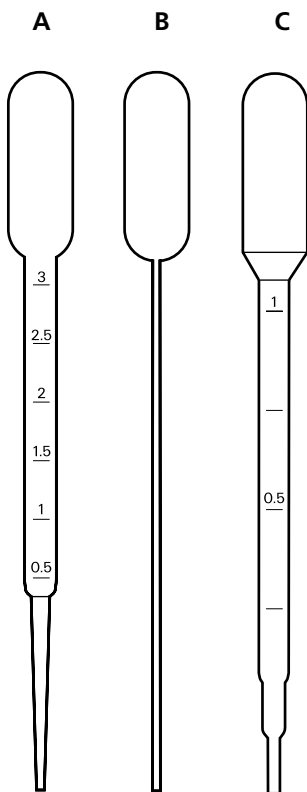

- A** 3ml graduated – suitable for blood banking and general laboratory use
- B** Narrow stem – suitable for use as a freeze vial, sedimentation and transport
- C** 1ml graduated – suitable for general laboratory use, storage and transport of samples



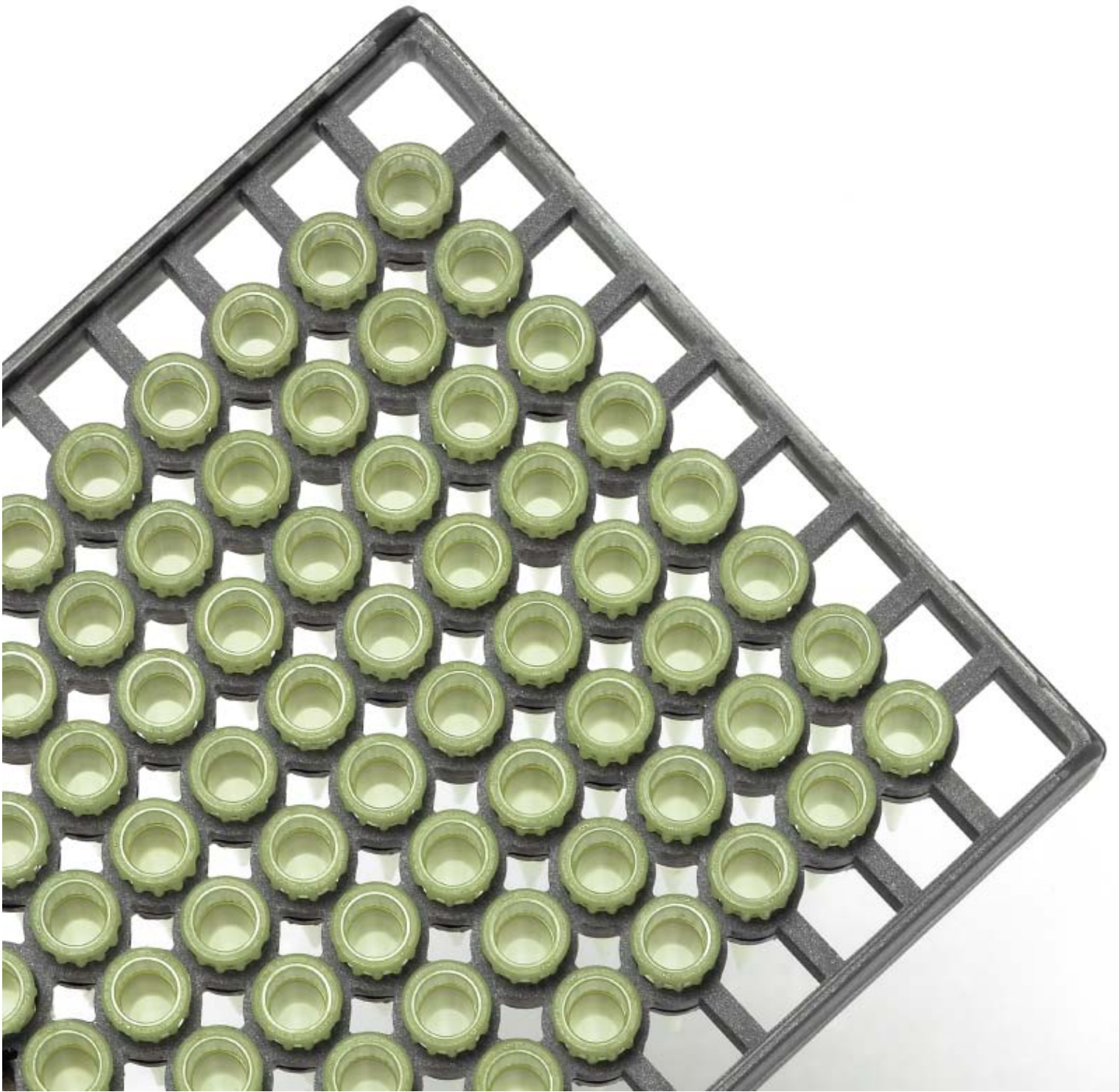

# Pipette Tips



## Pipette Tips,



- Manufactured from virgin polypropylene and metal-free pigments
- High translucency for excellent visibility of sample
- Hydrophobic surface to minimise fluid retention
- Precision moulded for clean delivery
- Non-sterile and autoclavable at 121°C
- Available bulk packed, an economical choice for the busy laboratory, or as rack packed refills for ease of handling

## Gilson, Clear 0.5–10µl

BCT10



Product Code	Packaging	Sterility	Inner Pack Qty	Case Qty
BCT10	Bulk	NS	1000	2000
BCTR10	Racked	NS	96	480

## Eppendorf, Clear 0.5-10µl

BCT20

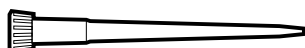

Product Code	Packaging	Sterility	Inner Pack Qty	Case Qty
BCT20	Bulk	NS	1000	2000
BCTR20	Racked	NS	96	480

## Gilson, Yellow 5-200µl

BCT25



Product Code	Packaging	Sterility	Inner Pack Qty	Case Qty
BCT25	Bulk	NS	1000	2000
BCB25	Bulk	NS	1000	25000
BCTR25	Racked	NS	96	480

## Universal, Yellow 5-200µl

BCT30



Product Code	Packaging	Sterility	Inner Pack Qty	Case Qty
BCT30	Bulk	NS	1000	2000
BCB30	Bulk	NS	1000	25000
BCTR30	Racked	NS	96	480

## Oxford, Clear 10-200µl

BCT40



Product Code	Packaging	Sterility	Inner Pack Qty	Case Qty
BCT40	Bulk	NS	1000	2000



## MLA, Clear 5-200µl

Product Code	Packaging	Sterility	Inner Pack Qty	Case Qty
BCT50	Bulk	NS	1000	2000

BCT50

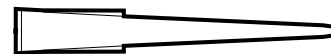

## Biohit, Clear 5-300µl

Product Code	Packaging	Sterility	Inner Pack Qty	Case Qty
BCT60	Bulk	NS	1000	2000
BCTR60	Racked	NS	96	480

BCT60



## Universal/Eppendorf, Blue 100-1000µl

Product Code	Packaging	Sterility	Inner Pack Qty	Case Qty
BCT70	Bulk	NS	1000	1000
BCB70	Bulk	NS	1000	10000
BCTR70	Racked	NS	96	480
BCT70S	Inner bags of 5	IRR	5	1000

BCT70



## Oxford, Blue 50-1000µl

Product Code	Packaging	Sterility	Inner Pack Qty	Case Qty
BCT80	Bulk	NS	1000	1000

BCT80



## MLA, Clear 50-1000µl

Product Code	Packaging	Sterility	Inner Pack Qty	Case Qty
BCT90	Bulk	NS	1000	1000

BCT90

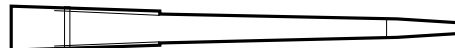



# pipette tips

## Gilson, Clear 1000-5000µl

BCT100

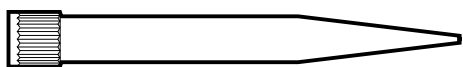

Product Code	Packaging	Sterility	Inner Pack Qty	Case Qty
BCT100	Bulk	NS	250	1000

## Biohit, Clear 1000-5000µl

BCT110

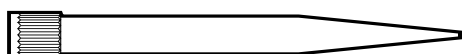

Product Code	Packaging	Sterility	Inner Pack Qty	Case Qty
BCT110	Bulk	NS	250	1000



Tips are available to fit most popular pipettors including Gilson, Finnpiquette, Oxford and Eppendorf. Consult the Tip/Pipettor Compatibility Chart on page 91 of the Technical Information section



## Pipette Tip Boxes

- For use with the racked tips detailed above
- Manufactured from sturdy polycarbonate with a sliding lid for ease of access
- Boxes help maintain cleanliness and also hold tips firmly for rapid connection to the pipettor
- Fully autoclavable at 121°C

Product Code	Description	Sterility	Qty
BCR10	Universal box for racked tip re-fills, up to 1000µl	PC	10
BCR20	Box for 5ml tips only (BCT100/110)	PP	1





# Swabs



## Swabs, Transport



- Primary sample collection and transport device for bacteria
- Contains media for the maintenance of bacterial sample during transport to the laboratory
- CE marked as Class IIa in accordance with the Medical Device Directive 93/42/EEC (for transient invasive use)
- In vitro use only
- Unique packaging system combines a nitrogen flushed aluminium inner bag with a laminated film pouch to prevent oxidation and dehydration of the media, ensuring optimum performance
- Venturi design enhances performance by helping to eliminate the incidence of bubbles and breaks in the agar gel
- Each batch of product is tested for performance using a wide range of aerobic and anaerobic pathogens to ensure adequate recoveries
- Certificate of Sterility and Quality Assurance is available on request
- Lot number, expiry date and tamper evident tube ensure complete traceability and sterility
- Soft rayon swab tips, inert and non-toxic to micro-organisms and patients

Product Code	Media	Applicator/ Tip	Cap Colour	Use	Sterility	Inner Pack Qty	Shelf Pack Qty	Case Qty
18108CST	Amies	Plastic/Rayon	Blue	Throat, vagina, wound and skin	IRR	1	50	500
18114CST	Amies with charcoal	Plastic/Rayon	Black	Throat, vagina, wound and urogenital	IRR	1	50	500
18110CST	Amies	Aluminium/ Rayon	Orange	Paediatric or urethral	IRR	1	50	500
18116CST	Amies with charcoal	Aluminium/ Rayon	Orange	Urogenital	IRR	1	50	500
18190CST	Amies	Twisted wire/Rayon	Blue	Pernasal	IRR	1	50	500
18192CST	Amies with charcoal	Twisted wire/Rayon	Blue	Pernasal	IRR	1	50	500
18111CST	Stuart agar	Plastic/Rayon	Blue	General purpose	IRR	1	50	500



For more details on the unique Venturi design of the Sterilin transport swabs, refer to page 92 of the Technical Information section

# Swabs, Transport M40



As for the standard transport swabs above but with the following added benefits;

- Complies with the American NCCLS M40-A and the German DIN 58942-4 standards
- Extended length of time for bacterial survival – 48 hours (minimum)
- Wider temperature range – comparable performance at both room temperature and 4°C
- Improvements to the swab tip give a superior performance



Product Code	Media	Applicator/ Tip	Cap Colour	Use	Sterility	Inner Pack Qty	Shelf Pack Qty	Case Qty
408CST	Amies	Plastic/Rayon	Red	General purpose	IRR	1	50	500
414CST	Amies with charcoal	Plastic/Rayon	Black	Urogenital	IRR	1	50	500

**i** For further information on the M40 Swabs please refer to page 93 of the Technical Information section

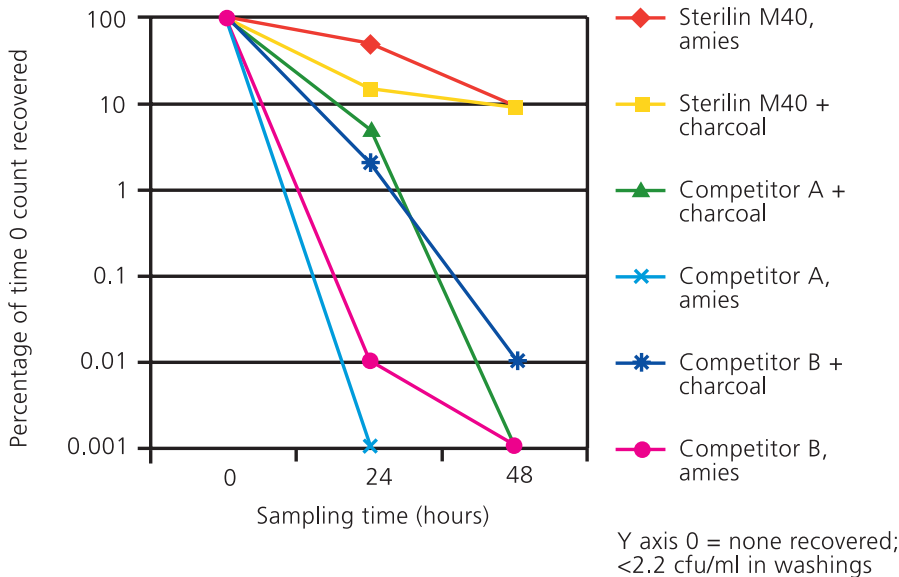



## Swabs, Viral and Chlamydia



- For the collection and transport of viruses and Chlamydia
- CE marked as Class IIa in accordance with the Medical Device Directive 93/42/EEC (for transient invasive use)
- In vitro use only
- Contains special media for the optimal recovery of viral pathogens or Chlamydia
- An inert non-toxic polyurethane sponge contains the liquid transport medium. This ensures the swab tip is bathed in media at all times
- CE marked as Class IIa Medical Device

Product Code	Applicator/ Tip	Cap Colour	Use	Sterility	Inner Pack Qty	Case Qty
144C	Plastic/Dacron	Yellow	Chlamydia	IRR	1	25
145C	Aluminium/Dacron	Yellow	Chlamydia	IRR	1	25
147C	Plastic/Dacron	Pink	Viruses	IRR	1	25
148C	Aluminium/Dacron	Pink	Viruses	IRR	1	25



## Swabs, Plain in a Tube



- Primary sample collection device for bacteria
- CE marked as Class IIa in accordance with the Medical Device Directive 93/42/EEC (for transient invasive use)
- Colour coded caps for ease of identification
- Supplied in a tube for ease of handling

Product Code	Applicator/ Tip	Cap Colour	Use	Sterility	Inner Pack Qty	Case Qty
F150CA	Wood/Cotton	Red	General purpose	IRR	1	100
F155CA	Plastic/Rayon	White	General purpose	IRR	1	100
F160CA	Aluminium/Rayon	Orange	Ear, nose, vaginal or urethral	IRR	1	100
F168CA	Twisted wire/Rayon	Blue	Pernasal and nasopharyngeal	IRR	1	100
451CST	Plastic/Cotton, Vegetale protein coated	Yellow	Vegetable protein coating reduces overgrowth	IRR	1	100
F152CA	Wood/Cotton, Charcoal coated	Black	Charcoal neutralises inhibitory effects of cotton	IRR	1	100
170C	Plastic/Dacron	Blue	ATP free for hygiene monitoring	IRR	1	100



Must be processed as soon as possible after sampling to avoid dehydration of the sample and possible non-recovery of pathogens



## Swabs, Plain in a Peel Pouch



- Ideal for immediate plating of swabs

Product Code	Applicator	Tip	Use	Sterility	Inner Pack Qty	Case Qty
165KS01	Wood	Cotton	General purpose	EO	1	1000
165KS100	Wood	Cotton	General purpose	EO	100	2500
164KS01	Plastic	Rayon	General purpose	EO	1	1000



## Swabs, Environmental

- For environmental sampling, particularly in the food and pharmaceutical industries
- Available in easy to use kit format consisting of a sealed tube with neutralising buffer, capped swab and sampling template
- Sterile sampling templates, 10cm x 10cm (100cm<sup>2</sup>), enable accurate calculation of colony forming units per cm<sup>2</sup>
- Alginate tipped swabs (903C) dissolve fully to ensure complete delivery of microbial sample into the SRK solution

Product Code	Description	Shaft Length (cm)	Applicator Material	Inner Pack Qty	Case Qty
902C	Swab rinse kit, 10ml solution, separate swab, dacron tip	13	PS	1	25
903C	Swab rinse kit, 10ml solution, separate swab, alginate tip	13	PS	1	25
904C	Swab rinse kit, 10ml solution, separate swab, large rayon tip	13	PS	1	25
922C	Swab rinse kit, 10ml solution, integral dacron tip swab	9	PS	1	50
926C	Swab rinse kit, 10ml solution, integral dacron tip swab,	9	PS	50	50
905C	Square sampling kit, 902C with square sampling template	13	PS	1	10
T2905C	Plastic square sampling template 10cm x 10cm	-	-	5	50

 For method of use please refer to page 93 of the Technical Information section

 For constituents of the rinse solution please see page 93 of the Technical Information section





## Swabs – Flocked Plain

- Utilises innovative nylon fibre technology
- Unbeatable sample collection and release;
  - sample release from the flocked swab is at least 95% compared with 25% with a regular fibre swab
  - vitally important if the sample to be collected is particularly small
- PCR compatible for molecular analysis;
  - Manufactured from completely inert components
  - Certified RNase and DNase free
- For forensic purposes product is available certified human DNA free and with a moulded breakpoint so that it can be easily broken into a 2ml collection vial
- Available either in a paper peel pouch or in a plain dry tube



501CS01



502CS01



503CS01



511CS01



516CS01

## Flocked Swabs – individually wrapped in paper peel pouch

Product Code	Description	Applicator/Tip	Sterility	Case Qty
501CS01	Minitip flocked swab	Plastic/Nylon fibre	IRR	100
502CS01	Regular flocked swab	Plastic/Nylon fibre	IRR	100
503CS01	Flexible nasopharyngeal minitip flocked swab	Plastic/Nylon fibre	IRR	100
511CS01	Endocervical flocked swab	Plastic/Nylon fibre	IRR	50
516CS01	Neonatal minitip flocked swab	Plastic/Nylon fibre	IRR	50



551C



552C



553C



516C

## Flocked Swabs – individually wrapped in plain dry tube

Product Code	Description	Applicator/Tip	Sterility	Case Qty
551C	Minitip flocked swab	Plastic/Nylon fibre	EO	100
552C	Regular flocked swab	Plastic/Nylon fibre	EO	100
553C	Flexible nasopharyngeal minitip flocked swab	Plastic/Nylon fibre	EO	100
516C	Neonatal minitip flocked swab	Plastic/Nylon fibre	EO	50

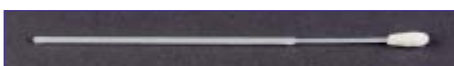

3520CS01

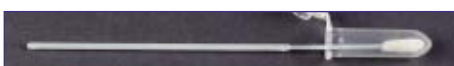

3520CA

## Forensic Swabs – certified human DNA free

Product Code	Description	Applicator/Tip	Sterility	Case Qty
3520CS01	Regular flocked swab with breakpoint, individually wrapped in plastic peel pouch	Plastic/Nylon fibre	IRR	100
3520CA	Regular flocked swab with breakpoint + 2ml tube, individually wrapped in plastic peel pouch	Plastic/Nylon fibre	IRR	100
3520CF	Regular flocked swab with breakpoint + 2ml tube with evaporation duct, individually wrapped in plastic peel pouch	Plastic/Nylon fibre	IRR	100

# Swabs, Transport – Universal Transport Medium (UTM)

- Ideal for the collection, transport, maintenance and frozen storage of Viruses, Chlamydia, Mycoplasma and Ureaplasma
- Suitable for cell culture, Rapid Antigen Detection, DFA, EIA, PCR and nucleic acid amplification assays
- Room temperature stable and incorporates a cryoprotectant
- 3ml volume, formulation includes antibiotics to inhibit bacterial and fungal flora in patient samples
- Free standing polypropylene skirted tube with conical base enabling convenient sample preparation - simply vortex and inoculate direct into tissue culture
- Available as filled tubes with a choice of separate individually wrapped swabs or a collection kit with the swab included
- Glass beads in the tube help with the release and dispersion of the patient sample from the swab



Product Code	Description	Applicator/Tip	Sterility	Case Qty
305C	UTM, 3ml medium + nasopharyngeal flocked swab	Plastic/Nylon Fibre	IRR	50
328C	UTM, 3ml medium + standard Dacron swab	Plastic/Nylon Fibre	AS/IRR	50
330C	UTM, 3ml medium, tube only	N/A	AS	50
346C	UTM, 3ml medium + regular flocked swab	Plastic/Nylon Fibre	AS/IRR	50
347C	UTM, 3ml medium + neonatal flocked swab	Plastic/Nylon Fibre	AS/IRR	50
350C	UTM, 1ml medium, tube only	N/A	AS	50
359C	UTM, 1ml medium + regular flocked swab	Plastic/Nylon Fibre	AS/IRR	50
360C	UTM, 1ml medium + nasopharyngeal flocked swab	Plastic/Nylon Fibre	IRR	50
361C	UTM, 1ml medium + minitip flocked swab	Plastic/Nylon Fibre	IRR	50



### Method of use

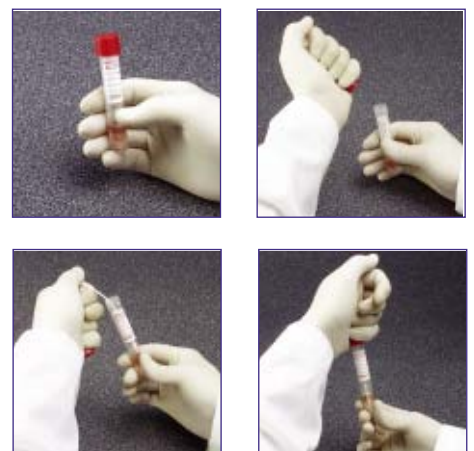



## Swabs, Transport – e-Swab

- Pre-labelled tube with 1ml liquid medium and flocked swab
- 1ml medium enables multi-test analysis - gram stain, multiple culture or automation
- Flocked swab – increased sample collection and release
- Maintains viability of aerobes, anaerobes and fastidious bacteria for up to 48 hrs at room temperature
- Can be processed using standard laboratory procedures for bacterial culture and molecular detection of bacteria, viruses and Chlamydia
- Preserves nucleic acids and antigens of bacteria, viruses and Chlamydia
- Free of enzymes and inhibitors that may interfere with nucleic acid amplification assays

Product Code	Description	Applicator/Tip	Sterility	Case Qty
480CE	Transport swab, liquid amies, regular flocked swab	Plastic/Nylon Fibre	IRR	50
481CE	Transport swab, liquid amies, minitip flocked swab	Plastic/Nylon Fibre	IRR	50
482CE	Transport swab, liquid amies, pernasal flocked swab	Plastic/Nylon Fibre	IRR	50
483CE	Transport swab, liquid amies, urethral flocked swab	Plastic/Nylon Fibre	IRR	50
484CE	Transport swab, liquid amies, paediatric flocked swab	Plastic/Nylon Fibre	IRR	50

### Method of use







## Tubes and Vials



## Cryogenic Vials

- Suitable for the cryogenic storage of biological material, human or animal cells
- Performs well both in low temperature freezers and the gas phase of liquid nitrogen
- RNase and DNase free and certified non-pyrogenic to 0.03EU/ml
- Silicone washer ensures excellent seal to temperatures as low as -196°C
- Have a large white marking area and printed graduations
- Thick vial wall for strength and additional safety
- Choice of self standing or round bottom :
  - Self standing have a universal locking base for use with the workstation
  - Round bottom ensures contents can be completely expelled
- The cap and base are both manufactured in polypropylene, and therefore have the same rate of expansion, which further enhances the leakproof qualities of these vials at changing temperatures



## Cryogenic Vials, Internal Thread

- Internal threaded product is considered to give the best seal possible
- Has a good flush profile
- Round bottom tube can be centrifuged up to RCF value of 14,000 xg

Product Code	Description	Capacity (ml)	Material	Sterility	Inner Pack Qty	Case Qty
1CRIS	Cryovial, self standing	1.2	PP	IRR	100	500
2CRIS	Cryovial, self standing	2.0	PP	IRR	100	500
2CRIR	Cryovial, round bottom	2.0	PP	IRR	100	500
4CRIS	Cryovial, self standing	4.0	PP	IRR	100	500
4CRIR	Cryovial, round bottom	4.0	PP	IRR	100	500
5CRIR	Cryovial, round bottom	5.0	PP	IRR	100	500

**i** The cryogenic vials detailed above are not recommended for use in the liquid phase of liquid nitrogen. Trapped liquid nitrogen in the vial, when brought up to room temperature, can cause pressure build up and lead to possible explosion or leakage.



## Cryogenic Vials, External Thread

- External threaded cap design helps to reduce the possibility of contamination
- The cap features a long skirt and smooth thread design for one handed aseptic methods
- Round bottomed tube can be centrifuged up to RCF value of 17,000 xg

Product Code	Description	Capacity (ml)	Material	Sterility	Inner Pack Qty	Case Qty
1CRES	Cryovial, self standing	1.2	PP	IRR	100	500
2CRES	Cryovial, self standing	2.0	PP	IRR	100	500
2CRES	Cryovial, round bottom	2.0	PP	IRR	100	500
3CRES	Cryovial, self standing	3.0	PP	IRR	100	500
4CRES	Cryovial, self standing	4.0	PP	IRR	100	500
5CRES	Cryovial, self standing	5.0	PP	IRR	100	500

**i** The cryogenic vials detailed above are not recommended for use in the liquid phase of liquid nitrogen. Trapped liquid nitrogen in the vial, when brought up to room temperature, can cause pressure build up and lead to possible explosion or leakage.



## Cryogenic Vials, Cap Inserts

- Fit precisely into the cryogenic vial cap to enable colour coding of samples for easier identification

Product Code	Description	Material	Inner Pack Qty	Case Qty
CRINM	Assorted cap inserts	PP	100	500



## Cryogenic Vials, Heat Sealable

- Suitable for the cryogenic storage of biological material, human or animal cells
- Manufactured from polyethylene
- 2ml volume
- Supplied as open vial complete with push on cap
- Vial can be sealed using the cap provided or by means of heated tweezers or forceps
- Gamma irradiated to ensure sterility

Product Code	Description	Capacity (ml)	Material Base/Cap	Sterility	Case Qty
35002S	Cryovial, heat sealable	2.0	PE/LDPE	IRR	200

**i** Integrity of the seal can be checked by immersing in a chilled solution of 70% ethanol containing 1% methylene blue. Penetration of the dye into the vial indicates lack of complete seal.



## Cryogenic Vial, Workstation

- For use with self standing cryogenic tubes having a universal locking base
- Tubes securely lock into the wells, allowing for simple one handed operation of the vial
- Accommodates up to 50 tubes
- Manufactured from polypropylene and fully autoclavable
- Each position is identified with an alpha numeric index to aid sample identification
- Strong handles make the workstation safe and easy to carry
- Rubber feet ensure stability on the bench

Product Code	Description	Material	Inner Pack Qty	Case Qty
WKS1	Workstation rack	PP	1	4



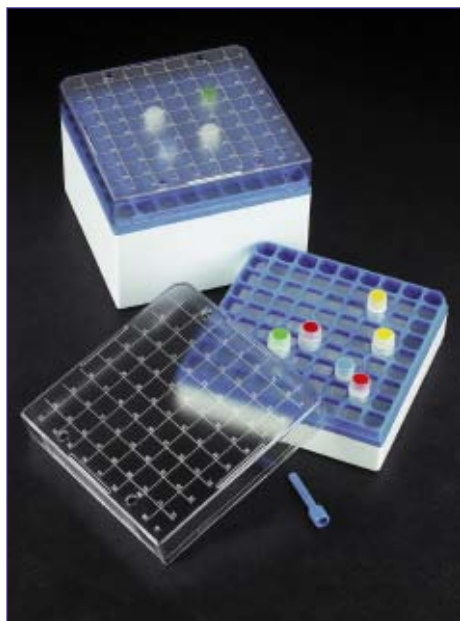

## Cryogenic Vials, Storage Boxes

- Suitable for the storage of vials from 1.0ml to 5.0 ml volumes
- Made of strong polycarbonate to ensure suitability at temperatures between -196°C and +121°C
- Autoclavable at 121°C for 20 minutes
- Transparent cover enables clear view of the box contents
- Box cover has a single orientation fit and a numbered grid for easy sample identification
- Supplied with a vial picker for the easy removal of vials
- Surface of cover accepts writing with cryogenic marker pens to aid inventory control

Product Code	Description	Material	Inner Pack Qty	Case Qty
CRBOX1	Storage box, 81 places for 1.0ml & 2.0ml vials	PC	4	24
CRBOX2	Storage box, 81 places for 3.0ml & 4.0ml vials	PC	6	12
CRBOX3	Storage box, 81 places for 5.0ml vials	PC	5	10
CRBOX4	Storage box, 100 places for 1.0ml & 2.0ml vials	PC	4	24



## Scintillation Vial, 20ml

- Ideal for use in liquid scintillation counting, beta/gamma counting and for sample storage
- Precision manufactured from either glass or polypropylene for strength and chemical resistance
- Quarter turn screw cap ensures excellent sample containment

Product Code	Description	Volume (ml)	Material	Sterility	OD x H (mm)	Inner Pack Qty	Case Qty
S31	Scintillation vial and cap	20	PP/PE	NS	26.5 x 60	1000	1000
38091	Scintillation vial and cap	20	G/UREA	NS	27 x 60	500	500



## Scintillation Vial Insert, 6ml

- With flush fitting cap, ideal as insert for glass and plastic scintillation vials
- Ideal for use in liquid scintillation counting and beta/gamma counting when savings in reagent are required
- Precision manufactured from polypropylene for strength and chemical resistance
- Material clarity enables visibility of reagent volume
- Time saving push on cap provides a secure seal
- Easy write on cap aids sample identification

Product Code	Description	Volume (ml)	Material	Sterility	OD x H (mm)	Inner Pack Qty	Case Qty
505	Scintillation vial insert and cap	6	PP/PE	NS	14.5 x 58	250	1000





## Tubes, Microcentrifuge, 1.5ml

- Recommended maximum RCF 20,000xg in suitably balanced rotors
- Manufactured from robust transparent polypropylene
- Able to withstand autoclaving, boiling, freezing and high speed centrifugation
- Graduations at 0.5ml, 1.0ml and 1.5ml

Product Code	Description	H x OD (mm)	Material	Sterility	Inner Pack Qty	Case Qty
2150N	Micro-centrifuge tube	41 x 11	PP	NS	500	10,000
2150R	Micro-centrifuge tube rack (holds 20)	210 x 70 x 37	PP	NS	1	1



## Tubes, Centrifuge, 13.5ml, Round Base

- Recommended RCF 3,200 x g in suitably balanced rotors
- Capped product aseptically manufactured from virgin polystyrene
- Moulded graduation marks at 5ml and 10ml
- Wadded or non-wadded cap

Product Code	Description	Capacity (ml)	H x OD (mm)	Material (Base/Cap)	Sterility	Case Qty
142B	Centrifuge tube, no cap	13.5	100 x 16	PS	NS	1200
147A	Push fit cap for 142B	-	-	PE	NS	1200
142AS	Centrifuge tube with non-wadded screw cap	13.5	100 x 16	PS/PE	AS	450
142ASR	Centrifuge tube with wadded screw cap	13.5	100 x 16	PS/PE	AS	450



## Tubes, Centrifuge, 13.5ml, Conical Base

- Recommended RCF 3,200 x g in suitably balanced rotors
- Capped product aseptically manufactured from virgin polystyrene
- Moulded graduation marks at 5ml and 10ml
- Wadded or non-wadded cap

Product Code	Description	Capacity (ml)	H x OD (mm)	Material (Base/Cap)	Sterility	Case Qty
144B	Centrifuge tube, no cap	13.5	100 x 16	PS	NS	1200
147A	Push fit cap for 144B	-	-	PE	NS	1200
144AS	Centrifuge tube with non-wadded screw cap	13.5	100 x 16	PS/PE	AS	450
36100	Centrifuge tube with wadded screw cap	13.5	110 x 16	PS/PE	AS	450





## Tubes, Centrifuge, 15ml

- Recommended RCF values:
  - Polypropylene 15ml centrifuge tubes 6,000 x g
  - Polystyrene 15ml centrifuge tubes 3,500 x g
- Manufactured from either optically clear polystyrene or high clarity polypropylene
- Polypropylene is chemically more resistant than polystyrene and allows higher centrifugation speeds
- Gamma irradiated to ensure sterility and non-pyrogenic to < 0.25 EU/ml
- Simple one-handed cap operation, facilitating single-handed aseptic techniques
- Flat cap to allow for identification marking
- Crisp white printed graduations on tube body with large marking strip for labelling
- Moulded graduations on the cone of tube
- Available in polystyrene foam racks or bulk packed

Product Code	Description	Capacity (ml)	H x OD (mm)	Bulk/Racked	Sterility	Material (Tube/Cap)	Inner Pack	Case Qty
15PPB	Centrifuge tube	15	120 x 17	Bulk	IRR	PP/PE	50	800
15PPR	Centrifuge tube	15	120 x 17	Racked	IRR	PP/PE	50	450
15PSB	Centrifuge tube	15	120 x 17	Bulk	IRR	PS/PE	50	800
15PSR	Centrifuge tube	15	120 x 17	Racked	IRR	PS/PE	50	450



## Tubes, Centrifuge, 50ml

- Recommended RCF 7,000 x g in suitably balanced rotor
- Manufactured from high clarity polypropylene
- Gamma irradiated to ensure sterility and non-pyrogenic to < 0.25 EU/ml
- Conical base and available in a choice of free standing (skirted) and non-skirted designs
- Crisp white printed graduations with large marking strip for labelling
- Flat cap allows for identification marking
- Moulded graduation mark at 50ml

Product Code	Description	Capacity (ml)	H x OD (mm)	Sterility	Material	Inner Pack Qty	Case Qty
36050NPG	Centrifuge tube, skirted	50	115 x 31	IRR	PP/PE	25	250
36050CPG	Centrifuge tube, non-skirted	50	115 x 31	IRR	PP/PE	25	250

**i** Non-skirted 50ml tube supplied with one polystyrene foam rack per case

**i** For full table of recommended RCF values for Sterilin centrifuge tubes and containers, please refer to page 94 of the Technical Information section



## Tubes, Flat Base, Push Cap



- Suitable for samples up to 2ml in volume
- Manufactured from virgin polystyrene
- CE marked in accordance with the European Directive 98/79/EC
- Available labelled for sample identification
- Tubes and caps packed separately

Product Code	Description	Capacity (ml)	Label	OH x OD (mm)	Material (Tube/Cap)	Sterility	Case Qty
NA2	Tube, push cap	2	None	48.5 x 11.5	PS/PE	NS	1500
NA2L	Tube, push cap	2	Printed	48.5 x 11.5	PS/PE	NS	1500



## Tubes, Flat Base, Screw Cap



- Suitable for samples ranging from 5ml to 10ml
- Manufactured from virgin polystyrene
- CE marked in accordance with the European Directive 98/79/EC
- Available labelled for sample identification

Product Code	Description	Capacity (ml)	Label	OH x OD (mm)	Material (Tube/Cap)	Sterility	Case Qty
Z5PS	Tube, screw cap	5	Printed	54.5 x 17.0	PS/PE	NS	1000
Z5PSNL	Tube, screw cap	5	None	54.5 x 17.0	PS/PE	NS	1000
Z10PS	Tube, screw cap	10	Printed	100.0 x 17.0	PS/PE	NS	500
Z10PSNL	Tube, screw cap	10	None	100.0 x 17.0	PS/PE	NS	500



## Tubes, Conical Base, Screw Cap



- Suitable for samples ranging from 5ml to 10ml
- Manufactured from chemically resistant polypropylene
- CE marked in accordance with the European Directive 98/79/EC

Product Code	Description	Capacity (ml)	Label	OH x OD (mm)	Material (Tube/Cap)	Sterility	Case Qty
Z5PE	Tube, with skirt, screw cap	5	Printed	56.5 x 17.5	PP/PE	NS	1000
Z5PENL	Tube, with skirt, screw cap	5	None	56.5 x 17.5	PP/PE	NS	1000
Z10PE	Tube, with skirt, screw cap	10	Printed	96.0 x 17.5	PP/PE	NS	500
Z10PENL	Tube, with skirt, screw cap	10	None	96.0 x 17.5	PP/PE	NS	500





# tubes and vials



## Tubes, Round Base, Plastic

- Manufactured from transparent polystyrene or tough polypropylene
- Suitable for samples ranging from 0.6ml to 11ml
- Provide a safe and convenient alternative to glass

Product Code	Description	H x OD (mm)	Capacity (ml)	Material	Sterility	Inner Pack Qty	Case Qty
RT15	Tube	40 x 6	0.6	PS	NS	1000	10,000
112	Tube	40 x 11	2.3	PS	NS	1000	1000
RT20	Tube	50 x 6	1.0	PS	NS	1000	10,000
RT25	Tube	65 x 10	2.7	PS	NS	500	6000
30908	Tube, LP3	64 x 11	2.5	PS	NS	2500	2500
RT30	Tube, LP4	75 x 12	4.9	PS	NS	250	3500
30890	Tube, LP4	75 x 12	4.9	PP	NS	1800	1800
30924	Tube, LP5	75 x 13	5.5	PS	NS	1500	1500
30932	Tube, LP6	95 x 16	11	PS	NS	750	750



## Caps to fit Round Base Tubes

- Push fit caps to fit round bottom tube listed above

Product Code	Description	Material	Sterility	Inner Pack Qty	Case Qty
C2A	Cap for RT30 / 30890	PE	NS	3500	3500
30981	Cap for 30924	PE	NS	6000	6000





## Tubes, Round Base, Soda Glass

- Suitable for samples ranging from 2ml to 20ml
- Provides greater chemical resistance than plastic
- Supplied without caps

Product Code	Description	Capacity (ml)	H x OD (mm)	Material	Sterility	Inner Pack Qty	Case Qty
49684	Round base tube	3	75 x 10	Soda glass	NS	250	1000
49635	Round base tube	5	75 x 12	Soda glass	NS	250	1000



## Tubes, Round Base, Borosilicate Glass, PYREX® Rimless

- Manufactured from Pyrex® borosilicate glass
- High resistance to temperature and chemical attack
- Ideal for use with samples sensitive to leaching from plastic tubes
- Supplied without caps
- Autoclavable at 121°C

Product Code	Description	Capacity (ml)	H x OD (mm)	Sterility	Inner Pack Qty	Case Qty
99445-10	Glass tube	4.0	75 x 10	NS	250	1000
99445-12	Glass tube	6.0	75 x 12	NS	250	1000
99445-13	Glass tube	10.0	100 x 13	NS	250	1000
99445-15	Glass tube	11.0	85 x 15	NS	250	1000
99445-16	Glass tube	15.0	100 x 16	NS	250	1000
99445-16X	Glass tube	19.0	125 x 16	NS	250	1000
99445-16XX	Glass tube	23.0	150 x 16	NS	250	1000
99445-18	Glass tube	28.5	150 x 18	NS	250	500
99445-20	Glass tube	36.0	150 x 20	NS	250	500



## Tubes, Culture, Round Base, Borosilicate Glass, Screw Neck PYREX®

- Manufactured from Pyrex® borosilicate glass
- High resistance to temperature and chemical attack
- Ideal for use with samples sensitive to leaching from plastic tubes
- Supplied without caps
- Autoclavable at 121°C

Product Code	Description	Capacity (ml)	H x OD (mm)	Sterility	Inner Pack Qty	Case Qty
99449-13	Glass tube	7.5	100 x 13	NS	250	1000
99449-16	Glass tube	11.5	100 x 16	NS	250	1000
99449-16X	Glass tube	15.0	125 x 16	NS	250	1000
99449-16XX	Glass tube	19.0	150 x 16	NS	250	1000
99449-20	Glass tube	24.0	125 x 20	NS	250	500
99449-20X	Glass tube	30.0	150 x 20	NS	250	500



 Screw caps to fit these tubes are detailed on page 66



## Tubes, Culture, Flat Base, Borosilicate Glass, Screw Neck

**PYREX®**

- Manufactured from Pyrex® borosilicate glass
- High resistance to temperature and chemical attack
- Ideal for use with samples sensitive to leaching from plastic tubes
- Supplied without caps
- Autoclavable at 121°C

Product Code	Description	Capacity (ml)	H x OD (mm)	Sterility	Inner Pack Qty	Case Qty
99448-16	Glass culture tube	17.0	125 x 16	NS	250	1000
99448-19	Glass culture tube	29.5	145 x 20	NS	250	500



## Caps to fit Glass Tubes

- Phenolic caps to fit screw neck tubes 99449 and 99448, with choice of:
  - Rubber liner
  - PTFE liner for inert sealing face
- Autoclavable at 121°C

Product Code	Description	Liner	ID (mm)	Case Qty
99999-13	Screw cap	Rubber	13	1000
99999-15	Screw cap	Rubber	16	1000
99999-18	Screw cap	Rubber	20	1000
9998-13	Screw cap	PTFE	13	288
9998-15	Screw cap	PTFE	16	288
9998-18	Screw cap	PTFE	20	192



## Tubes, Culture, Round Base, Plastic

- Suitable for suspension culture procedures
- Two position cap:
  - Leave loose for gas exchange
  - Push down for tight seal
- Large white marker area for easy labelling
- Printed graduations

Product Code	Description	Capacity (ml)	H x OD (mm)	Material (Tube/Cap)	Sterility	Inner Pack Qty	Case Qty
75CTS1	Culture tube	4	75 x 12	PS/PE	IRR	1	500
75CTS	Culture tube	4	75 x 12	PS/PE	IRR	25	500
100CTS1	Culture tube	12	100 x 17	PS/PE	IRR	1	500
100CTS	Culture tube	12	100 x 17	PS/PE	IRR	25	500
75CTP1	Culture tube	4	75 x 12	PP/PE	IRR	1	500
75CTP	Culture tube	4	75 x 12	PP/PE	IRR	25	500
100CTP1	Culture tube	12	100 x 17	PP/PE	IRR	1	500
100CTP	Culture tube	12	100 x 17	PP/PE	IRR	25	500



# Weighing Boats

## Weighing Boats

- Manufactured from high impact polystyrene
- Radiused corners and sloping sides for complete sample transfer
- Hydrophobic surface ensures no absorption of water from atmosphere or sample
- Flat base for a secure, firm rest on the balance pan
- Choice of standard or anti-static boats

## Weighing Boats, Standard, White, Diamond

- Flexible to allow the formation of a funnel for easy pouring to another vessel
- Suitable for coloured powders and samples



Product Code	Description	Capacity (ml)	Dimensions (mm)	Sterility	Inner Pack Qty	Case Qty
30311	Weighing boat, small	5	55 x 30	NS	500	1000
30314	Weighing boat, medium	30	80 x 60	NS	500	500
30317	Weighing boat, large	100	120 x 100	NS	250	250

## Weighing Boats, Standard, White, Square

- Ideal for general purpose weighing
- Suitable for coloured powders and samples

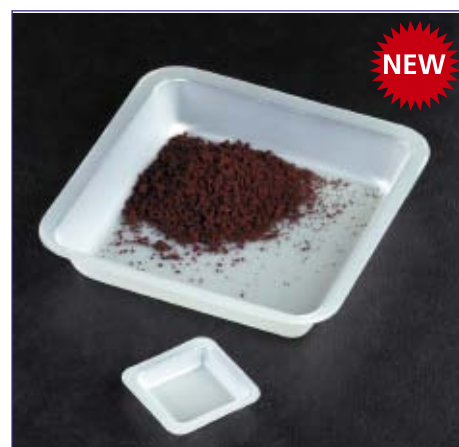

Product Code	Description	Capacity (ml)	Dimensions (mm)	Sterility	Inner Pack Qty	Case Qty
30205	Weighing boat, small	7	44 x 44	NS	250	1000
30254	Weighing boat, medium	100	80 x 80	NS	250	1000
30304	Weighing boat, large	250	140 x 140	NS	250	1000

## Weighing Boats, Standard, Black, Diamond

- Flexible to allow the formation of a funnel for easy pouring to another vessel
- Suitable for white powders and samples



Product Code	Description	Capacity (ml)	Dimensions (mm)	Sterility	Inner Pack Qty	Case Qty
30312	Weighing boat, small	5	55 x 30	NS	500	1000
30315	Weighing boat, medium	30	80 x 60	NS	500	500
30318	Weighing boat, large	100	120 x 100	NS	250	250



## Weighing Boats, Standard, Black, Square

- Ideal for general purpose weighing
- Suitable for white powders and samples

Product Code	Description	Capacity (ml)	Dimensions (mm)	Sterility	Inner Pack Qty	Case Qty
30206	Weighing boat, small	7	44 x 44	NS	250	1000
30255	Weighing boat, medium	100	80 x 80	NS	250	1000
30305	Weighing boat, large	250	140 x 140	NS	250	1000



## Weighing Boats, Anti-Static

- Avoids the retention of powders by static electricity
- Raw material modified to significantly reduce the charge relaxation time in comparison to standard weigh boats. Majority of electrostatic charge dissipates within seconds when earthed on the balance pan
- Ideal for use with fine powders, eg talcum powder

## Weighing Boats, Anti Static, White, Diamond

Product Code	Description	Capacity (ml)	Dimensions (mm)	Sterility	Inner Pack Qty	Case Qty
30331	Anti-static boat, small	5	55 x 30	NS	500	1000
30334	Anti-static boat, medium	30	80 x 60	NS	500	500
30337	Anti-static boat, large	100	120 x 100	NS	250	250



## Weighing Boats, Anti-Static, White, Square

Product Code	Description	Capacity (ml)	Dimensions (mm)	Sterility	Inner Pack Qty	Case Qty
30321	Anti-static boat, small	7	44 x 44	NS	250	1000
30324	Anti-static boat, medium	100	80 x 80	NS	250	1000
30327	Anti-static boat, large	250	140 x 140	NS	250	1000





## Weighing Boats, Anti-Static, Black, Diamond

Product Code	Description	Capacity (ml)	Dimensions (mm)	Sterility	Inner Pack Qty	Case Qty
30332	Anti-static boat, small	5	55 x 30	NS	500	1000
30335	Anti-static boat, medium	30	80 x 60	NS	500	500
30338	Anti-static boat, large	100	120 x 100	NS	250	250



## Weighing Boats, Anti-Static, Black, Square

Product Code	Description	Capacity (ml)	Dimensions (mm)	Sterility	Inner Pack Qty	Case Qty
30322	Anti-static boat, small	7	44 x 44	NS	250	1000
30325	Anti-static boat, medium	100	80 x 80	NS	250	1000
30328	Anti-static boat, large	250	140 x 140	NS	250	1000



## Weighing, Beakers

- Ideal for weighing small volumes of liquids
- Temperature resistant to 90°C
- Manufactured from high impact polystyrene
- Packed in handy dispensers for ease of use
- The 5ml and 20ml beaker are recommended for use with flame photometer samples

Product Code	Description	Capacity (ml)	Sterility	Inner Pack Qty	Case Qty
30353	Weighing beaker	5	NS	100	1000
30403	Weighing beaker	10	NS	100	1000
30452	Weighing beaker	20	NS	100	500
30502	Weighing beaker	50	NS	100	500



# **IWAKI** Cell Biology

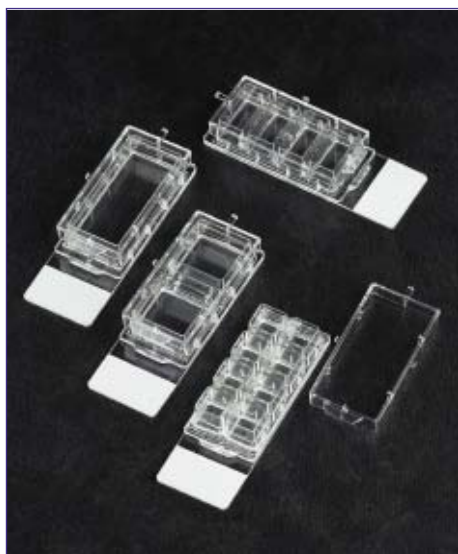

## Chamber Slides

- Polystyrene chamber attached to a glass microscope slide by means of a non-toxic silicone rubber
- Ideal for the culture, fixation, staining and observation of cells all on one slide
- Independent chambers help simultaneous multi-cultures with low risk of cross-contamination
- Plastic chambers can be removed following culture
- Supplied sterile in easy to open tray packaging

Product Code	Description	No of Chambers	Chamber Capacity (ml)	Chamber Dimensions (mm)	Material Chamber/Slide	Sterility	Inner Pack Qty	Case Qty
5702-001	Chamber slide	1	10	19 x 44	PS/Glass	EO	10	20
5712-002	Chamber slide	2	4.5	19 x 19	PS/Glass	EO	10	20
5722-004	Chamber slide	4	2	9 x 19	PS/Glass	EO	10	20
5732-008	Chamber slide	8	1	9 x 9	PS/Glass	EO	10	20

- i** Do not sterilise in autoclave  
Do not use with organic solvents



## Dishes, Tissue Culture Treated

- Manufactured from optically clear, premium grade, non-toxic virgin polystyrene
- Assured sterile by gamma irradiation and certified non-pyrogenic to less than 0.5EU/ml
- Feature a special tissue culture (TC) treatment that ensures optimum cell attachment and growth
- Stacking rings for stability and vents for improved gas exchange
- An easy grip feature on all 35, 60, and 150mm dishes facilitates ease of handling
- Thick, flat bases enhance optical clarity and reduce bowing. Dish lids are untreated to minimise condensation

Product Code	Description	OD x Height (mm)	Growth Area (cm <sup>2</sup> )	Sterility	Inner Pack Qty	Case Qty
3000-035	Tissue culture dish	35 x 10	9	IRR	10	300
3010-060	Tissue culture dish	60 x 15	21	IRR	10	300
3020-100	Tissue culture dish	100 x 20	55	IRR	10	300
3030-150	Tissue culture dish	150 x 20	148	IRR	5	60

## Dishes, Non-Treated

- Manufactured from optically clear, premium grade, non-toxic virgin polystyrene
- Assured sterile by gamma irradiation and are certified non-pyrogenic to less than 0.5EU/ml
- Ideal for suspension cultures or plant cell culture
- Stacking rings for stability and vents for improved gas exchange
- An easy grip feature on all 35, 60, and 150mm dishes facilitates ease of handling
- Thick, flat bases enhance optical clarity and reduce bowing

Product Code	Description	OD x Height (mm)	Growth Area (cm <sup>2</sup> )	Sterility	Inner Pack Qty	Case Qty
1000-035	Tissue culture dish	35 x 10	9	IRR	10	300
1010-060	Tissue culture dish	60 x 15	21	IRR	10	300
1020-100	Tissue culture dish	100 x 20	55	IRR	10	300
1030-150	Tissue culture dish	150 x 20	148	IRR	5	60

- i** For our extensive range of glass based products for use with confocal microscopes, please refer to page 77 & 78



## ELISA/Assay Plates, High Binding

- Manufactured from high clarity virgin polystyrene
- Flat or round base well designs
- Uniform plate thickness for precise optical clarity and low background interference
- Alpha-numeric labelling for fast, accurate identification and measurement
- Chimney well design minimises the risk of cross contamination
- Low evaporation lid or sealing film available
- Compatible with standard microplate washers, dispensers and readers

Product Code	Description	Base	Material	Well ID x Depth (mm)	Well Capacity (ml)	Sterility Qty	Inner Pack	Case Qty
3801-096	ELISA plate 96 well	Flat	PS	6.4 x 10.8	0.35	IRR	10	50
3802-096	ELISA plate 96 well	Round	PS	6.9 x 10.8	0.35	IRR	10	50
1803-096	Lid for 3801, 3802	-	PS	-	-	NS	1	50
1804-096	Sealing film (83 x 134mm)	-	PET	-	-	NS	50	50



## ELISA/Assay Plates, Low Binding

- Flat or round base well designs
- Uniform plate thickness for precise optical clarity and low background interference
- Alpha-numeric labelling for fast, accurate identification and measurement
- Chimney well design minimises the risk of cross contamination
- Low evaporation lid or sealing film available
- PVC assay plate is a flexible alternative to polystyrene and provides faster transfer of heat for PCR reactions
- Compatible with standard microplate washers, dispensers and readers

Product Code	Description	Base	Material	Well ID x Depth (mm)	Well Capacity (ml)	Sterility Qty	Inner Pack	Case Qty
3881-096	Assay plate 96 well	Flat	PS	6.4 x 10.8	0.35	NS	10	50
3882-096	Assay plate 96 well	Round	PS	6.9 x 10.8	0.35	NS	10	50
3883-096	Assay plate 96 well, Flexible	Flat	PVC	6.4 x 10.8	0.35	NS	10	50
1803-096	Lid for 3881, 3882	-	PS	-	-	NS	1	50
1804-096	Sealing film (83 x 134mm)	-	PET	-	-	NS	50	50



**i** For our extensive range of glass based products for use with confocal microscopes, please refer to page 77 & 78

**i** For information on specific application for each well shape and the details on the binding capacity of the Iwaki ELISA plates please refer to page 90 of the Technical Information section



## Filters, Syringe

- Tissue culture grade filters have been designed to meet the exacting standards of today's cell biologists
- Assured sterile by gamma irradiation and certified non-pyrogenic to less than 0.5EU/ml
- Choice of filter housing and membrane pore size to satisfy most filtration requirements
- Cellulose acetate membrane that is both detergent free and low binding
- Transparent acrylic membrane housing available for improved visual inspection
- Membrane support permits positive or negative filtration
- Designed with minimum dead space to reduce sample loss
- Supplied in individual blister packs and ready for use
- PES membrane available for faster flow rates and low protein binding
- Recommended for sterile filtering of protein solutions, tissue culture media and additives

Product Code	Description	Membrane Diameter (mm)	Membrane Material	Pore Size (µm)	Housing Material	Flow Rate (ml/min)	Residual Volume (ml)	Inner Pack Qty	Case Qty
2012-003	Syringe filter	3	CA	0.22	PP	0.5	0.01	1	50
2032-013	Syringe filter	13	CA	0.22	PP	12.0	0.07	1	50
2052-025	Syringe filter	25	CA	0.22	ACS	61.2	0.21	1	50
2053-025	Syringe filter	25	CA	0.45	ACS	94.6	0.21	1	50
2132-050	Syringe filter	50	CA	0.22	PP	170.0	1.00	1	10
2055 033	Syringe filter	33	PES	0.22	ACS	175.0	0.10	1	50



## Flasks, Tissue Culture Treated, Two-Position Cap

- Features a special tissue culture surface treatment that ensures optimum cell anchorage and growth
- Manufactured from clear, premium grade, non-toxic, virgin polystyrene
- Assured sterile by gamma irradiation and certified non-pyrogenic to less than 0.5EU/ml
- Each flask is pressure tested to ensure leak free performance
- Two-position cap enables an airtight seal or manual venting
- The wide neck design allows easy pipetting and cell scraping on all flask sizes
- Moulded graduations facilitate accurate filling
- Anti-tilt skirts, stacking rims and feet for extra stability
- Resealable inner packaging to protect unused product
- Lot number etched into 25, 75 and 150cm<sup>2</sup> product to ensure complete traceability

Product Code	Description	Surface Area (cm <sup>2</sup> )	Neck	Capacity (ml)	Inner Pack Qty	Case Qty
3100-025	Tissue culture flask	25	Canted	70	10	300
3102-025	Tissue culture flask, slim	25	Canted	60	10	300
3110-075	Tissue culture flask	75	Canted	270	5	100
3120-150	Tissue culture flask	150	Canted	600	5	40
3160-225	Tissue culture flask	225	Straight	900	5	25



 Accessory cell scraper available, please refer to page 79 product code 9010-320

 For our extensive range of substrate coated products please refer to pages 80 & 81





## Flasks, Tissue Culture Treated, Filter-Vented Cap

- Filter vented caps feature a 0.2µm hydrophobic membrane that eliminates bacterial and fungal contamination
- Manufactured from clear, premium grade, non-toxic, virgin polystyrene
- Assured sterile by gamma irradiation and certified non-pyrogenic to less than 0.5EU/ml
- Each flask is pressure tested to ensure leak free performance
- The wide neck design allows easy pipetting and cell scraping on all flask sizes
- Moulded graduations facilitate accurate filling
- Anti-tilt skirts, stacking rims and feet for extra stability
- Resealable inner packaging to protect unused product
- Lot number etched into 25, 75 and 150cm<sup>2</sup> product to ensure complete traceability
- Suitable for cultures requiring constant gas exchange with the cap fully sealed
- Ideally suited for use in CO<sub>2</sub> incubators
- Features a special tissue culture surface treatment that ensures optimum cell anchorage and growth
- Each flask is supplied in sterile, easy to open, resealable packaging

### Vented Cap

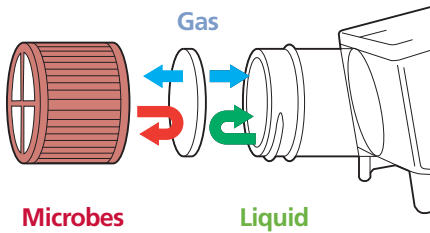

Product Code	Description	Surface Area (cm <sup>2</sup> )	Neck	Capacity (ml)	Inner Pack Qty	Case Qty
3103-025	Tissue culture flask	25	Canted	70	10	300
3113-025	Tissue culture flask, slim	25	Canted	60	10	300
3123-075	Tissue culture flask	75	Canted	270	5	100
3133-150	Tissue culture flask	150	Canted	600	5	40
3143-225	Tissue culture flask	225	Straight	900	5	25



## Flasks, Non-Treated, Two-Position Cap

- Hydrophobic surface ideally suited for hybridoma and suspension cell cultures
- Manufactured from clear, premium grade, non-toxic, virgin polystyrene
- Assured sterile by gamma irradiation and certified non-pyrogenic to less than 0.5EU/ml
- Each flask is pressure tested to ensure leak free performance
- Two-position cap enables an airtight seal or manual venting
- The wide neck design allows easy pipetting and cell scraping on all flask sizes
- Accurate graduations are moulded into each flask facilitating filling
- Anti-tilt skirts, stacking rims and feet for extra stability
- Small inner pack sizes with resealable packaging to protect unused product
- Lot number etched into 25, 75 and 150cm<sup>2</sup> product to ensure complete traceability

Product Code	Description	Surface Area (cm <sup>2</sup> )	Neck	Capacity (ml)	Inner Pack Qty	Case Qty
1100-025	Tissue culture flask	25	Canted	70	10	300
1110-075	Tissue culture flask	75	Canted	270	5	100
1160-225	Tissue culture flask	225	Straight	900	5	25

**i** Non treated flasks have a white cap for ease of identification. Outer packaging is also clearly marked 'NON TREATED'





## Glass Based, Dishes

AS RECOMMENDED BY 

- Glass or quartz coverslip attached to the base of a 35mm polystyrene dish with non-toxic silicone adhesive
- Specifically designed for the fluorescent measurement of live and dead cells at a higher magnification than that achievable through plastic dishes
- Quartz based dishes allow higher transmittance and measurement of lower fluorescence
- Ideal for confocal laser microscope studies
- Glass/quartz thickness 0.175 +/- 0.02mm
- Supplied sterile

Product Code	Description	Base Material	Coverslip Diameter (mm)	Sterility	Inner Pack Qty	Case Qty
3900-035	Quartz based dish	Quartz	27	EO	1	50
3901-035	Quartz based dish	Quartz	12	EO	1	50
3930-035	Glass based dish	Glass	27	EO	1	20
3931-035	Glass based dish	Glass	12	EO	1	20

### Transmittance

Material	Wavelength (nm)			
	200	300	350	400
Quartz	90.9	91.6	92.3	93.2
Glass	0.0	12.9	89.2	90.0

### Fluorescence (Relative value); Excitation wavelength 340 nm

Material	Wavelength (nm)						
	380	400	420	440	460	480	500
Quartz	5.7	8.6	10.3	6.3	4.0	2.4	2.1
Glass	9.7	16.3	20.1	15.2	12.4	11.5	14.1

 Do not sterilise in autoclave. Do not use with organic solvents

## Glass Based, Assay Plates

AS RECOMMENDED BY 

- Specifically designed for studying cellular interactions at the molecular level at a higher magnification than is achievable through plastic plates
- Superior optical clarity over conventional polystyrene alternatives makes them ideal for high transmittance microscope scanning
- Glass thickness 0.175 +/- 0.02mm
- Chimney well design reduces cell-to-cell contamination
- Low fluorescent background and black pigment reduces 'cross-talk'
- Especially suitable for use with confocal microscopy
- Low base design ensures readability of all wells by inverted microscopes
- Designed for applications such as:
  - Receptor-ligand detection through fluorescent probes
  - Cell based assays
  - Low-end sensitivity detections

Product Code	Description	No of Wells	Well Base	Well Capacity (µl)	Growth Area (cm <sup>2</sup> )	Lid	Sterility	Inner Pack Qty	Case Qty
5882-096	Glass based assay plate	96	Flat	300	0.32	None	NS	5	10
5883-384	Glass based assay plate	384	Flat	120	0.10	None	NS	5	10

 Imaging plane from bottom of plate < 0.5mm. Flatness across focal plane 100µm

 Do not sterilise in autoclave. Do not use with organic solvents



Photograph of confocal microscope courtesy of Leica Microsystems. For more information please go to [www.leica-microsystems.com](http://www.leica-microsystems.com)





## Glass Based, Culture Plates

AS RECOMMENDED BY

- Specifically designed for tissue culture applications linked with the observation of cells using confocal microscopy with fluorescent probes and multi point microscopes
- Superior optical clarity over conventional polystyrene alternatives makes them ideal for high transmittance microscope scanning
- Glass thickness 0.175 +/- 0.02mm
- Chimney well design reduces well to well contamination
- Low fluorescent background and black pigment reduces 'cross-talk'
- Especially suitable for use with confocal microscopy
- Supplied sterile

Product Code	Description	No of Wells	Well Base	Colour	Lid	Growth Area (cm <sup>2</sup> )	Sterility	Inner Pack Qty	Case Qty
5816-006	Glass based culture plate	6	Flat	Black	Yes	1.90	EO	1	10
5826-024	Glass based culture plate	24	Flat	Black	Yes	0.76	EO	1	10
5866-096	Glass based culture plate	96	Flat	Black	Yes	0.33	EO	1	10



Do not sterilise in autoclave. Do not use with organic solvents



For our extensive range of substrate coated glass based culture plates please refer to pages 80 & 81



## Multiwell Plates, Tissue Culture Treated

- Manufactured from premium grade virgin polystyrene
- Assured sterile by gamma irradiation and certified non-pyrogenic to less than 0.5EU/ml
- Suitable for single cell isolation through cell culture scale up
- Special surface treatment for optimal cell attachment and growth
- Raised well rims and chimney well design greatly reduce the risk of cross contamination
- Non-reversible lids minimising contamination from condensation
- Each well is alphanumerically labelled

Product Code	No of Wells	Well Base	Lid	Well ID x Depth (mm)	Well Capacity (ml)	Growth Area (cm <sup>2</sup> )	Inner Pack Qty	Case Qty
3810-006	6	Flat	Yes	34.6 x 17.5	16	9.4	1	50
3815-012	12	Flat	Yes	22.1 x 17.5	6.5	3.8	1	50
3820-024	24	Flat	Yes	15.5 x 17.3	3.4	2.0	1	50
3830-048	48	Flat	Yes	11.2 x 17.1	1.76	0.98	1	50
3860-096	96	Flat	Yes	6.4 x 10.8	0.35	0.32	1	50
3861-096	96	Flat	Yes	6.4 x 10.8	0.35	0.32	10	50
3870-096	96	Round	Yes	6.9 x 10.8	0.35	-	1	50



Pre-bar coded plates are available to special order. Please contact our Customer Service Department for further details



Accessory cell scraper available for 6, 12 and 24 well plates. Please refer to page 79, product code 9000-220



For our extensive range of substrate coated multiwell plates, please refer to pages 80 & 81



## Multi-Well Plates, Non-Treated

- Ideal for hybridoma or lymphocyte culture
- Manufactured from premium grade virgin polystyrene
- Assured sterile by gamma irradiation and certified non-pyrogenic to less than 0.5EU/ml
- Suitable for single cell isolation through to cell culture scale up
- Raised well rims and chimney well design greatly reduce the risk of cross contamination
- Non-reversible lids minimising contamination from condensation
- Each well is alphanumerically labelled

Product Code	No of Wells	Well Base	Lid	Well ID x Depth (mm)	Well Capacity (ml)	Growth Area (cm <sup>2</sup> )	Inner Pack Qty	Case Qty
1820-024	24	Flat	Yes	15.5 x 17.3	3.4	2.0	1	50
1830-048	48	Flat	Yes	11.2 x 17.1	1.76	0.98	1	50
3875-096	96	Round	No	6.9 x 10.8	0.35	-	1	50

 Pre-bar coded plates are available to special order. Please contact our Customer Service Department for further details



## Pipettes

For a full range of pipettes for tissue culture please refer to page 37

## Scrapers

- For the mechanical harvesting of cells
- Gentle silicone rubber blades
- Flask scraper with rotating blade for corners, for use with 75, 150 and 225cm<sup>2</sup> flasks
- Dish scraper with fixed blade for 6, 12 and 24 well plates and dishes

Product Code	Description	Blade Width x Length (mm)	Materials (Blade/Shaft)	Sterility	Inner Pack Qty	Case Qty
9000-220	Cell scraper for plates and dishes	11 x 220	Silicone Rubber/ABS resin	IRR	1	100
9010-320	Cell scraper for flasks	12 x 320	Silicone Rubber/ABS resin	IRR	1	100

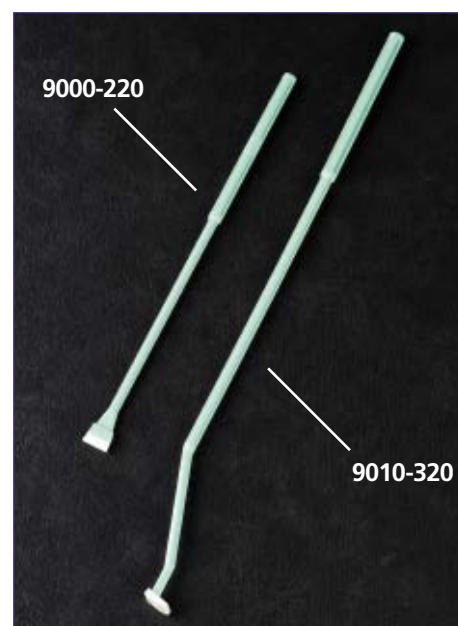





## Substrate Coated Products

- Iwaki protein substrate coated products promote differentiation of cultured cells
- The range supports both endothelial and exothelial cell growth
- Choice of Collagen, Poly-L-Lysine, Poly-Ethylene-Imine, Fibronectin, or Gelatin coated flasks, dishes and multiwell plates
- No refrigeration required
- All products are expiry dated

**i** Storage temperature of all substrate coated products should not be higher than 25°C  
Avoid storage in areas of high humidity

**i** Rapid temperature changes and exposure to UV irradiation may reduce the shelf life of the products



## Collagen Type 1 Coated Products

- Collagen Type 1 coated ware promotes excellent growth in the culturing of human keratinocytes, rat liver cells and mouse dorsal root ganglia neuron in serum free media
- Source - pig tendon
- Improves survival of primary cell cultures
- Improves cell attachment and increases cell proliferation rate for a variety of mammalian cells
- Suitable for the following applications:
  - Cell adhesion assays
  - Studies of effect of Collagen Type 1 on cells

Product Code	Description	Sterility	Inner Pack Qty	Case Qty
4000-010	Dish, 35mm	AS	10	200
4010-010	Dish, 60mm	AS	10	200
4020-010	Dish, 100mm	AS	10	120
4030-010	Dish, 150mm	AS	5	10
4810-010	Plate, 6 well	AS	1	20
4815-010	Plate, 12 well	AS	1	20
4820-010	Plate, 24 well	AS	1	20
4860-010	Plate, 96 well	AS	1	20
4100-010	Flask, 25cm <sup>2</sup>	AS	10	60
4110-010	Flask, 75cm <sup>2</sup>	AS	5	10
4160-010	Flask, 225cm <sup>2</sup>	AS	5	10
4816-010	Glass based culture plate, 6 wells	AS	1	10
4826-010	Glass based culture plate, 24 wells	AS	1	10
4866-010	Glass based culture plate, 96 wells	AS	1	10



## Fibronectin Coated Products

- Fibronectin coated dishes are suitable for culturing fibroblasts, hepatocytes and nerve cells in serum free media
- Source – fetal plasma
- Promotes cell attachment and proliferation

Product Code	Description	Sterility	Inner Pack Qty	Case Qty
4000-030	Dish, 35mm	AS	10	60
4010-030	Dish, 60mm	AS	10	40
4020-030	Dish, 100mm	AS	10	40





## Gelatin Coated Products

- Improves cell attachment
- Source – pig skin
- Ideal for primary cultures of myoblasts, liver cells or human endothelial cells

Product Code	Description	Sterility	Inner Pack Qty	Case Qty
4000-020	Dish, 35mm	AS	10	200
4010-020	Dish, 60mm	AS	10	200
4020-020	Dish, 100mm	AS	10	120
4810-020	Plate, 6 well	AS	1	20
4815-020	Plate, 12 well	AS	1	20
4820-020	Plate, 24 well	AS	1	20
4860-020	Plate, 96 well	AS	1	20
4100-020	Flask, 25cm <sup>2</sup>	AS	10	60

Non Coated Dish      Gelatin Coated Dish

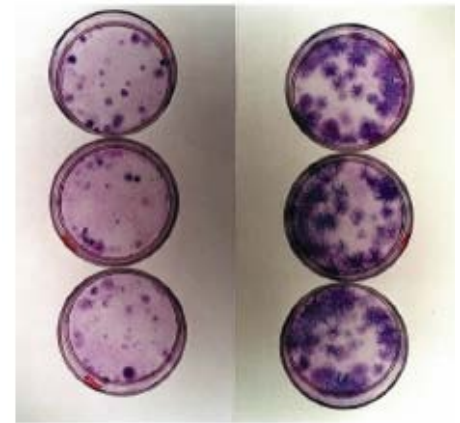

Chick Myoblasts

## Poly-L-Lysine Coated Products

- Suitable for primary culture of neuronal cells and transfected cell lines
- Source - chemically synthetic amino acid
- Suitable applications include:
  - Attachment and proliferation of a variety of cell lines
  - Cell differentiation and neurite outgrowth
  - Improving survival of primary neurons in culture

Product Code	Description	Sterility	Inner Pack Qty	Case Qty
4000-040	Dish, 35mm	AS	10	200
4010-040	Dish, 60mm	AS	10	200
4020-040	Dish, 100mm	AS	10	120



## Poly-Ethylene Imine Coated Products



- Particularly suitable for primary culture of neurons
- Source – chemically synthetic amino acid
- Suitable applications include:
  - Attachment and spreading of a variety of cell lines
  - Cell differentiation and neurite outgrowth
  - Improving survival of primary neurons in culture

Product Code	Description	Sterility	Inner Pack Qty	Case Qty
4816-060	Glass based culture plate, 24 well	AS	1	10
4826-060	Glass based culture plate, 48 well	AS	1	10
4866-060	Glass based culture plate, 96 well	AS	1	10



For more information on the suitability of different cell types on each substrate coated product, please refer to page 85 of the Technical Information section



## Thin Collagen Gel Membrane

- Novel Scaffold for three dimensional cell culture
- Uniform 20µm (re-hydrated) membrane attached to nylon ring to maintain structure
- Transparent, allowing for easy microscopic observation
- Enhanced gel strength enabling easy handling
- Excellent permeability enabling cell-cell interactions cultured on opposite sides of the membrane

Product Code	Description	OD (mm)	Diameter of Transparent Area (mm)	Material Membrane/ Ring	Sterility	Inner Pack Qty	Case Qty
VIT-C001	Thin Collagen Gel Membrane	33	24	Collagen Gel/ Nylon	IRR	1	6

## Tubes, Culture

For a full range of glass culture tubes please refer to pages 63 & 64

For a full range of plastic culture tubes please refer to page 64



## Tubes, Centrifuge, 15ml

- Recommended RCF values:
  - Polypropylene 15ml centrifuge tubes 9,400 x g
  - Polystyrene 15ml centrifuge tubes 1,800 x g
- Manufactured from clear polystyrene or opaque polypropylene
- Printed graduations and flat top triple sealed, HDPE cap
- Assured sterile by gamma irradiation and certified non-pyrogenic (<0.5EU/ml)
- Available in racks or convenient, easy to open re-sealable bulk packaging

Product Code	Description	Capacity (ml)	Racked/ Bulk	Material Base/Cap	Sterility	Inner Pack Qty	Case Qty
2322-015	Centrifuge tube	15	Racked	PS/HDPE	IRR	50	500
2324-015	Centrifuge tube	15	Bulk	PS/HDPE	IRR	25	500
2323-015	Centrifuge tube	15	Racked	PP/HDPE	IRR	50	500
2325-015	Centrifuge tube	15	Bulk	PP/HDPE	IRR	25	500



## Tubes, Centrifuge, 50ml

- Recommended RCF values:
  - Polypropylene 50ml centrifuge tubes 9,400 x g
  - Polystyrene 50ml centrifuge tubes 1,500 x g
- Manufactured from clear polystyrene or opaque polypropylene
- Printed graduations and flat top, triple sealed, HDPE cap
- Assured sterile by gamma irradiation and certified non-pyrogenic (<0.5EU/ml)
- Available in racks or convenient, easy to open, re-sealable bulk packaging

Product Code	Description	Capacity (ml)	Racked/ Bulk	Material Base/Cap	Sterility	Inner Pack Qty	Case Qty
2342-050	Centrifuge tube	50	Racked	PS/HDPE	IRR	25	300
2344-050	Centrifuge tube	50	Bulk	PS/HDPE	IRR	10	300
2343-050	Centrifuge tube	50	Racked	PP/HDPE	IRR	25	300
2345-050	Centrifuge tube	50	Bulk	PP/HDPE	IRR	10	300



For a further range of centrifuge tubes suitable for tissue culture applications, please refer to the Sterilin range on page 62



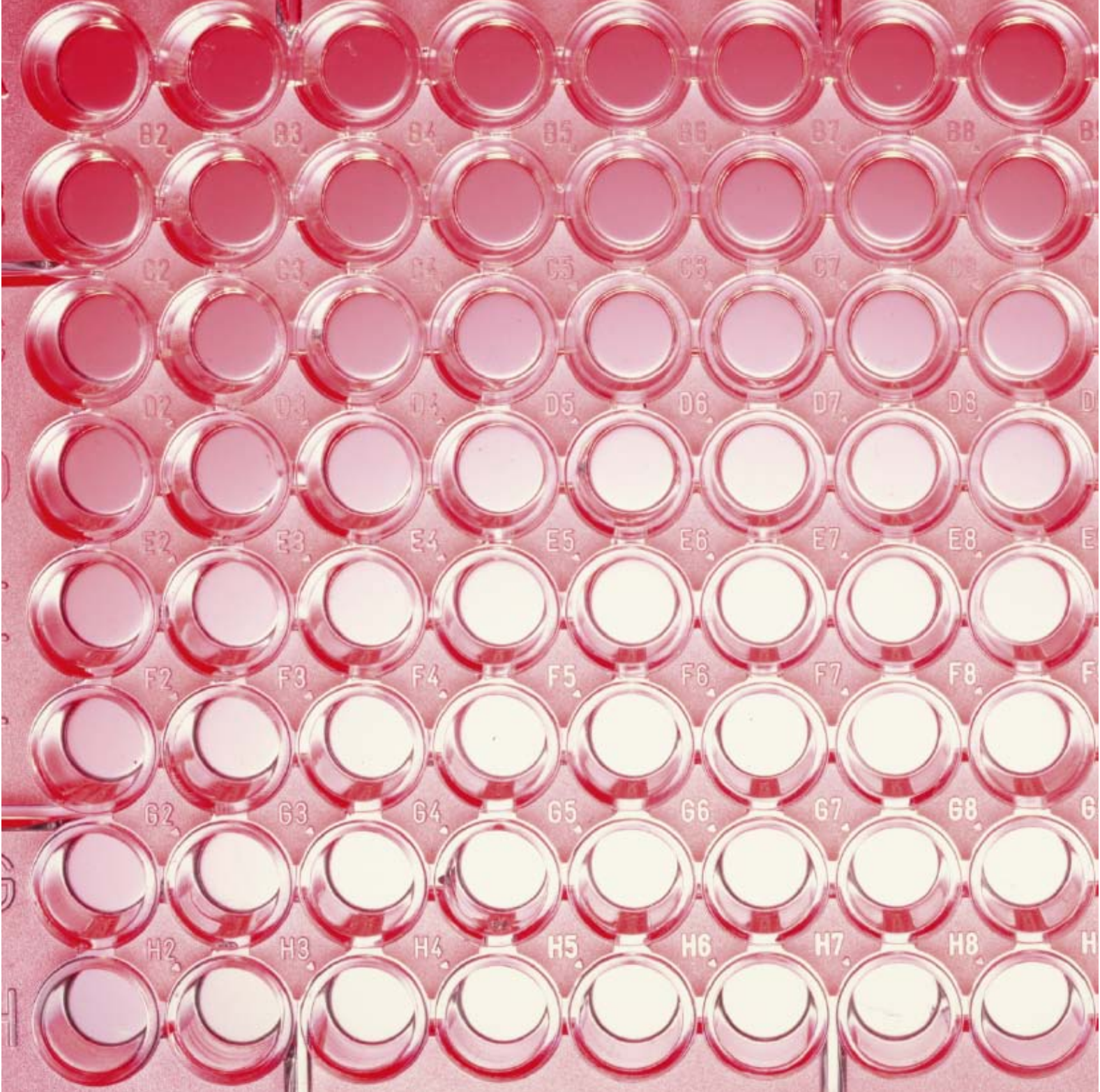

# Technical Information

## 1. Abbreviations

ABS	Acrylonitrile Butadiene Styrene
ACS	Acrylonitrilstyrene co-polymer
AL	Aluminium
AS	Aseptic Manufacture
CA	Cellulose Acetate
Dia	Diameter
EO	Ethylene Oxide
ID	Internal Diameter
IRR	Irradiated for Sterility
G	Glass
M	Metal, Tin Plate
NS	Non Sterile
OD	Outer Diameter
OH	Overall Height
PE	Polyethylene
PES	Polyethersulfone
PETG	Polyethylene Terephthalate
PMMA	Polymethyl Methacrylate
PP	Polypropylene
PS	Polystyrene
W	Wire, Epoxy Coated

## 2. Bags, Autoclave

(cat page 2 )

Recommendations for use:

- Vessels containing liquid should not be plugged or capped
- Do not put sharp objects such as broken glassware into an autoclave bag
- Add some water to bags of solid waste. The water will vapourise into steam and will drive out residual air once sterilisation temperature has been reached inside the bag
- Do not tightly seal the bag as this will prevent air escaping during the sterilisation process
- Do not overload autoclave. Leave sufficient room for thorough steam circulation
- For the decontamination and inactivation of particularly resistant biological waste, use High Temperature bags and autoclave at 135°C



## 3. Bags, Metal Closure

(cat page 3)

### Method of Use

- I. Tear off top of bag along perforation
- II. Use pull tabs to open bag
- III. Place sample in bag
- IV. Hold bag by wire ends and whirl three times to close (whirling the bag will form the tightest seal) or fold the tab over tightly three times to close (folding the tab should be used for larger bags)
- V. Bend wire ends onto bag to ensure bag remains closed
- VI. Sample contained in bag

To re-open the bag:

- Bend the wire ends away from the bag
- Unroll the tab
- Use pull tabs to open

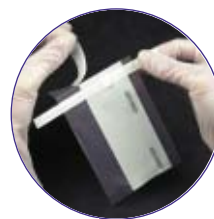

I.



II.



III.



IV.



V.



VI.

## 4. Cell Biology, Treated Products

( cat pages 72, 75, 76, 78 )



The Iwaki TC treated products (flasks, dishes, multiwells) undergo a special tissue culture treatment to enable them to support cell growth on their surfaces. This is primarily a treatment that makes the surface of the vessel hydrophobic and thus enhances cell attachment.



## 5. Cell Biology, Working Volumes

The following volumes are a general guideline only.

Customers should decide the media volume required dependant on the cell line being used

	Recommended Working Media Volume (ml)
<b>Culture Dishes</b>	
35 mm	2.0 - 3.0
60 mm	4.0 - 6.0
100 mm	10.0 - 15.0
150 mm	40.0 - 50.0
<b>Multi Well Plates</b>	
6 wells	2.0 - 3.0
12 wells	1.5 - 2.2
24 wells	0.5 - 1.0
48 wells	0.5 - 0.8
96 wells	0.1 - 0.2
<b>Culture Flasks</b>	
25 cm <sup>2</sup>	5.0 - 7.5
25 cm <sup>2</sup> slim	5.0 - 7.5
75 cm <sup>2</sup>	15 - 30
150 cm <sup>2</sup>	40 - 50
225 cm <sup>2</sup>	45 - 75

## 6. Cell Biology, Substrate Coated Products

(cat pages 80 & 81)

A problem that can occur when attempting to culture cells in-vivo is encouraging them to grow and proliferate on a plastic or glass base rather than on macromolecular connective tissue, which would bind them together in-vivo. This connective tissue, known as the extra cellular matrix, generally consists of proteins, polysaccharides and proteoglycans. To help combat this problem Iwaki have developed a range of tissue culture products coated with components of the extra cellular matrix. When placed in contact with these proteins, cells that are usually difficult to nurture in artificial environments:

- Show improved cell attachment and growth
- Exhibit lower requirements for serum
- Produce a monolayer of cells needed to show a cytopathic effect

This range also has significant other benefits over non-coated TC products or in-house coated product when the need to culture 'difficult' cells arises, namely:

- Saves time
- Ensures reproducibility
- Consistency in results

### a) Collagen Type I

Collagen type I is found in most tissues and organs, but can be found mainly in dermis, bone and tendons. As an integral part of the overall framework that holds cells and tissues together it has been recognised as a useful matrix for enhancing cell culture. The in vitro use of

collagen can improve cell attachment and increase proliferation rates for a variety of normal and transformed mammalian cell types

Collagen source – pig tendon

Storage should be at room temperature (not higher than 25°C)

Avoid storage in areas of high humidity

Rapid temperature changes and exposure to UV irradiation may reduce the shelf life of the product.

Suitable cell types include:

- Endothelial Cells
  - Primary human umbilical vein endothelial cells (HUVEC)
  - Foetal bovine heart endothelial cells (FBHE)
  - Primary porcine aortic endothelial cells
- Hepatocytes
  - Primary rat hepatocytes
  - Primary human hepatocytes
  - HepG2 cells
- Muscle Cells
  - Chick embryo myocytes and myoblasts
  - Rat myocytes and myoblasts
  - Skeletal muscle cells
  - Rat smooth muscle cells
  - Quail myoblasts
  - Human smooth muscle cells
  - Rat primary cardiomyocytes
  - Transfected MM41 skeletal myoblasts
- Rat PC12 Cells
- Other Cell Types
  - Transfected CHO cells
  - MDA-MB 435 tumour cells

### b) Fibronectin

Fibronectin exists in the plasma (as a dimer) and in the extracellular matrix and on cell surfaces (in multimeric form). Its main function is cell adhesion to the extracellular matrix that occurs through an interaction of its cell binding domain with fibronectin-specific cell surface receptors. Other domains of fibronectin also interact with collagen, heparin and cell surface glycosaminoglycans. It can promote the cell attachment, proliferation, differentiation and spreading of many cell types, especially fibroblasts.

Fibronectin source – foetal plasma

Storage should be at room temperature (not higher than 25°C)

Avoid storage in areas of high humidity

Rapid temperature changes and exposure to UV irradiation may reduce the shelf life of the product

Suitable cell types include:

- Fibroblasts
  - Hamster kidney cells, BHK-21
- Endothelial Cells
  - Capillary endothelial cells
  - Human umbilical vein endothelial cells
  - Microvascular endothelial cells
- Nerve Cells
  - Neuroblastoma cells
- Other Cell Types
  - Monocytes
  - 3T3 Preadipose cells
  - Human myeloma cell lines

## c) Gelatin

Gelatin is derived through the hydrolysis of collagen to produce a heterogeneous mixture of water-soluble proteins. It can be used to enhance the attachment of a wide variety of both normal and transfected cell types

Gelatin source – pig skin

Storage should be at room temperature (not higher than 25°C).

Avoid storage in areas of high humidity

Rapid temperature changes and exposure to UV irradiation may reduce the shelf life of the product

Suitable cell types include:

- Vascular Endothelial Cells
  - Primary human umbilical vein endothelial cells (HUVEC)
- Embryonic Stem Cells
- Muscle Cells
- F9 Teratocarcinoma Cells

## d) Poly-L-Lysine and Poly-Ethylene-Imine

These are chemically synthetic molecules used to enhance cell attachment by altering the charge on the surface of the tissue culture treated vessel from negative to positive. Poly-L-Lysine has been found to be especially effective when using serum free or serum reduced cultures where it also enhances the adsorption of serum or extracellular matrix proteins to the culture substrate. Both are suitable for the primary culture of nerve cells. Poly-Ethylene-Imine is especially suited for the primary culture of cells associated with the central nervous system.

Storage should be at room temperature (not higher than 25°C)

Avoid storage in areas of high humidity

Rapid temperature changes and exposure to UV irradiation may reduce the shelf life of the product

Suitable cell types include:

- Primary Neurons
  - Cerebellar granule
  - Cerebral cortex
  - Sympathetic neurons
  - Sciatic nerve
  - Cortical neurons
  - Spinal cord neurons
  - Septal neurons
  - Dorsal root ganglia
- Neuronal Cell Lines
- Glial Cells
- Transfected Cell Lines



Application	Collagen Type I	Fibronectin	Gelatin	PLL / PEI
Promotion of cell attachment and spreading	√	√	√	√
Cell adhesion assays	√	√		
Serum free/reduced serum culture	√	√		
Rapid expansion of cell populations	√	√		
Studies of effects of of coating type on behaviour	√	√		
Improving survival of of primary cells in culture	√	√		
Culture of normal and transfected F9 teratocarcinoma cells for gene expression			√	
Culture and promote proliferation of Human Umbilical Vein Endothelial Cells (HUVEC)	√	√	√	
Cell differentiation and neurite outgrowth				√
Attachment of fastidious transfected cell lines			√	
Support survival of primary primary neurons in culture			√	

## 7. CE Marking and the In Vitro Diagnostic Device Directive 98/79/EU

Many Sterilin products now carry a CE symbol in accordance with the European Directive 98/79/EU.

The Directive was introduced in 2003 to regulate the safety and performance of In Vitro Diagnostic Devices throughout the European Union. Manufacturers, such as Sterilin Ltd, are obliged by the Directive to adopt careful design, production and quality control of products that are classed as In Vitro Medical Devices. The latter includes Petri dishes, Specimen Containers and Multiwell Plates.

Sterilin branded products, which are covered by the Directive and CE marked, are clearly identified in this catalogue. Just look for the CE symbol against the catalogue entry.

It should be noted that the Directive does not apply to general laboratory products such as transfer pipettes. Hence these items are not CE marked.

For some products there is no clear distinction between In Vitro Diagnostic Devices and General Laboratory Products. In these cases Sterilin Ltd has chosen to adopt a responsible approach: it will not CE mark until it receives clarification from the European Commission.

For latest information please consult

[www.sterilin.co.uk](http://www.sterilin.co.uk) and click onto Technical Centre where this information can be found under Technical Data.

## 8. Chemical Resistance and Physical Properties of Polymers

■ Excellent resistance, can withstand use over a long period of time without change  
■ Good resistance, minor attack may occur over long periods of storage  
■ Limited resistance, moderate attack, product can be used for brief mixing and measuring  
■ Poor resistance, product becomes unstable on contact with chemical  
TL Translucent  
C Clear

	PS	PP	LDPE	HDPE	PETG
Acids-dilute	Green	Green	Green	Green	Green
Acids-concentrated	Orange	Green	Green	Green	Red
Alcohols	Green	Green	Green	Green	Green
Aldehydes	Red	Green	Yellow	Yellow	Red
Bases	Green	Green	Green	Green	Red
Chloroform	Red	Orange	Red	Orange	Red
Esters	Red	Yellow	Yellow	Yellow	Red
Formaldehyde	Red	Yellow	Yellow	Yellow	Red
Hydrocarbons-aliphatic	Red	Yellow	Orange	Yellow	Red
Hydrocarbons-aromatic	Red	Orange	Orange	Yellow	Red
Hydrocarbons-halogenated	Red	Orange	Red	Orange	Red
Ketones	Red	Yellow	Yellow	Yellow	Red
Oils, mineral	Green	Green	Orange	Yellow	Yellow
Oils, vegetable	Yellow	Yellow	Yellow	Yellow	Yellow
Oxidising agents	Red	Orange	Orange	Orange	Red

	PS	PP	LDPE	HDPE	PETG
Max Temp °C	70	135	80	120	60
Min Temp °C	-40	0	-50	-100	-80
Autoclavable	NO	YES	NO	NO	NO
Gamma Irradiation Sterilisation	YES	NO	YES	YES	YES
Transparency	C	TL	TL	TL	C
Gas Permeability N <sub>2</sub>	3	4.4	20	3	0.8
Gas Permeability CO <sub>2</sub>	75	92	280	45	4.5
Gas Permeability O <sub>2</sub>	15	28	60	10	1.1
Water Absorption %	0.05	<0.02	<0.01	<0.01	<0.1

mm cm<sup>2</sup>/cm<sup>2</sup>·sec (cm Hg) x 10<sup>10</sup>

### Key to abbreviations

(PS) Polystyrene

(PP) Polypropylene

(LDPE) Low density polyethylene

(HDPE) High density polyethylene

(PETG) Polyethylene Tetrphthalate

*This chemical resistance chart and table of physical properties is intended for general guidance only. We recommend that users satisfy themselves as to the compatibility between containers and proposed contents before use.*

## 9. Containers, Dimensions

(cat page 9)

Dimensions given throughout the catalogue are nominal unless otherwise stated.

Sterilin Ltd reserves the right to alter specifications without the prior notice as part of the company's policy of ongoing product improvement.

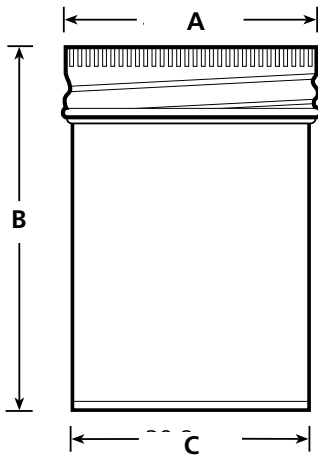

Container, Polypropylene, Hinged Lid

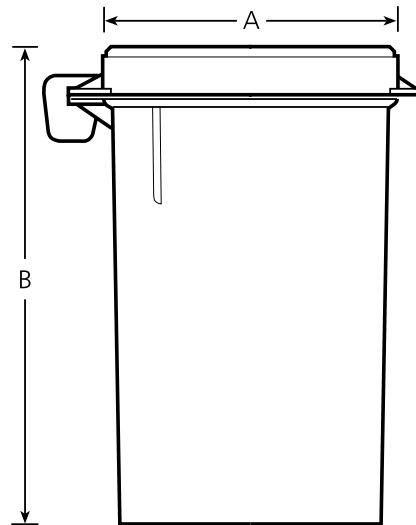

Product Code	A (mm)	B (mm)	Nominal Vol (ml)
52FLS / 52FLPLS	29	85	48
60FLS / 60FLPLS	31	78	53
100FLS / 100FLPLS	43	80	101
300FLS / 300FLPLS	75	88	296

Product	A (mm)	B (mm)	C (mm)
7ml Bijou, PS§	22.5	50.2	18.0
7ml Bijou, Glass	20.9	45.5	15.9
30ml Universal, PS	31.0	94.0	24.0
30ml Universal, PP	29.5	90.0	24.0
30ml Universal, Glass	26.6	84.8	21.4
40ml Container, PP	34.0	70.0	30.0
60ml Container, Plastic Cap, PS	35.0	61.0	39.2
60ml Container, Metal Cap, PS	44.5	61.0	39.2
60ml Container, Plastic Cap, PP	39.0	70.0	34.0
100ml Container, Plastic Cap, PS	51.0	78.0	44.0
100ml Container, Metal Cap, PS	49.5	77.0	44.0
125ml Container, Plastic Cap, PP	61.0	74.0	51.0
150ml Container, Metal Cap, PS	55.0	108.0	48.0
180ml Container, Plastic Cap, PP	61.0	102.0	51.0
250ml Container, Metal Cap, PS	65.5	119.5	58.0
250ml Container, Metal Cap, PP	65.0	118.0	58.0

Container, Polypropylene, Snap Cap

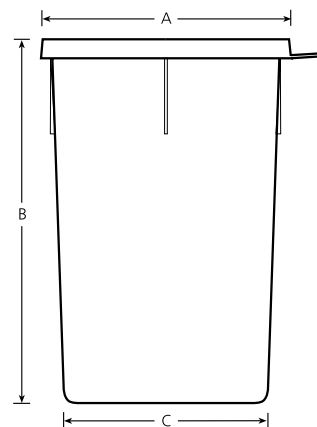

Product Code	A (mm)	B (mm)	C (mm)
202PPI	65	88	53
402PPI	85	100	70
1002PPI	105	130	88



## 10. Containers, Leak Test Standard

In many applications, particularly the healthcare sector, Sterilin containers will be used to contain both valuable and hazardous samples. Many of these samples will also be subjected to the rigours of hospital air transport systems. It is imperative that these products do not leak. As such, for the benefit and safety of both patients and clinicians, production samples of Sterilin containers are routinely leak tested in accordance with EN14254 Annexe D and BS5213

## 11. Containers, Double Bagged

(cat page 15)

### Method of Use

Sterilin branded double bagged containers are available for use in hospital theatres and other sterile environments. The procedure for use is detailed below:

1. Each container is supplied double wrapped and irradiated. An irradiation dot is affixed to each inner bag confirming complete sterility



2. The outer bag can be opened in the non-sterile environment by carefully tearing along the line as directed. The inner bag can easily be pulled from the outer bag by staff within the sterile operating area ensuring a 'sterile' transfer from one area to the next



3. The container can then be removed from the second bag within the sterile operating environment



## 12. Cuvettes

(cat page 21)

Sterilin cuvettes are manufactured from both polystyrene (PS) and polymethyl methacrylate (PMMA). The table below indicates the chemical resistance of both polymers for 30 minute exposure.

	PS	PMMA
Ammonia	√	√
Hexane	x	√
Hydrochloric acid, 36%	√	√
Hydrofluoric acid, 10%	√	√
Isopropanol	√	√
Sodium hydroxide	√	√



Please note:

Cuvettes should not be used for long-term storage of samples. When using hydrochloric acid, as the instrument can come under attack from the acid fumes, it is recommended that sealing film is used on the cuvette.

### What does "sorted by cavity number" mean?

A plastic injection mould with 8 separate cavities can produce 8 cuvettes at a time. To ensure best possible reproducibility, it is preferable to use product from the same cavity number. Cuvettes originating from each individual cavity are automatically packaged into the same carton. Therefore for best results, use cuvettes from one carton for each series of analyses

## 13. Microtitre Plates

(cat pages 30 & 73)

When selecting the type of microtitre plate required for a particular application, please use the table below for guidance:

Application	Type of Plate
DNA Libraries	Polystyrene, sterile with lid
High throughput screening of new and novel compounds	All types
EIA	Polystyrene
Luminescence	Polystyrene, white
Scintillation*	Polystyrene, white
Fluorescence	Polystyrene, black
Tissue culture growth studies	Polystyrene, TC treated, sterile with lid

\* With scintillation applications it is recommended to use polystyrene friendly scintillation cocktails

### Choice of well shape

#### 'U' Well

- Improves washing in ELISAs
- Enhances sensitivity in fluorescent applications
- Facilitates observation of agglutination reactions

#### Flat Well

- Provides optimal optical characteristics for polystyrene plates
- Suitable for reagent injection reactions

#### V' Well

- Ideal profile for centrifugation and sedimentation



## 14. Petri Dishes

(cat page 31)

Sterilin 90mm, 140mm and 100mm square Petri dishes are manufactured in accordance with the British Standard 611 part 2. With stringent dimensional controls, we can ensure product quality and consistency making them ideal for use with most automatic plate pourers

### Basic criteria with associated benefits are as follows:

Specification	Benefit
Free from discolouration and weld marks	Good optical quality
Consistent dimensions without rough edges	Will fit plate pourers, safe to use
Minimum vent height	Adequate gas flow - consistent results
Rigidity to resist excessive deformation when handled	No distortion in use
Must not distort at 60°C	Pour with hot agar
Must resist fracture up to 19.61N	Reduced risk of breakage
Stability - incline stack to 12 degrees	Safe and easy to use
Free from loose particles greater than 100µm in diameter	No false positives when using automatic colony counters
Manufacture must be by aseptic means or the or the product must be terminally sterilised	Assured level of sterility
All packaging must be clearly marked with the manufacturers mark, BS611 and 'in vitro use only	Visible guarantee of a quality product



## 15. Pipette Tips, Compatibility Chart

(cat page 45)

Product Code	Description	Colour	Capacity (ul)	Eppendorf	Gilson	Finnpipette	Biohit	Elkay (Exelpette)	Jencons (Sealpette)	Nichiryo	Socorex	Oxford	MLA
<b>Standard</b>													
BCT10	Pipette Tip, micro	Clear	0.5 – 10	✓	✓	✓	✓	✓	✓	✓			
BCT20	Pipette Tip, micro	Clear	0.5 – 10	✓	✓	✓	✓	✓	✓	✓	✓		
BCT25	Pipette Tip	Yellow	2 – 200	✓	✓	✓	✓	✓	✓	✓			
BCT30	Pipette Tip	Yellow	2 – 200	✓	✓	✓	✓	✓	✓	✓	✓		
BCT40	Pipette Tip	Clear	5 – 200									✓	
BCT50	Pipette Tip	Clear	5 – 200										✓
BCT60	Pipette Tip	Clear	5 – 300		✓	✓	✓						
BCT70	Pipette Tip	Blue	100 – 1000	✓	✓	✓	✓	✓	✓	✓	✓		
BCT70S	Pipette Tip	Blue	100 – 1000	✓	✓	✓	✓	✓	✓	✓	✓		
BCT80	Pipette Tip	Blue	50 – 1000									✓	
BCT90	Pipette Tip	Clear	50 – 1000										✓
BCT100	Pipette Tip, macro	Blue	1000 – 5000		✓							✓	✓
BCT110	Pipette Tip, macro	Clear	1000 - 5000	✓		✓	✓		✓		✓		
<b>Bulk</b>													
BCB25	Pipette Tip	Yellow	2 – 200	✓	✓	✓	✓	✓	✓	✓			
BCB30	Pipette Tip	Yellow	5 - 200	✓	✓	✓	✓	✓	✓	✓	✓		
BCB70	Pipette Tip	Blue	2 – 200	✓	✓	✓	✓	✓	✓	✓	✓		
<b>Racked</b>													
BCTR10	Racked Pipette Tip, micro	Clear	0.5 - 10	✓	✓	✓	✓	✓	✓	✓			
BCTR20	Racked Pipette Tip, micro	Clear	0.5 – 10	✓	✓	✓	✓	✓	✓	✓	✓		
BCTR25	Racked Pipette Tip	Yellow	5 – 200	✓	✓	✓	✓	✓	✓	✓			
BCTR30	Racked Pipette Tip	Yellow	5 – 200	✓	✓	✓	✓	✓	✓	✓	✓		
BCTR60	Racked Pipette Tip	Clear	5 – 300		✓	✓	✓						
BCTR70	Racked Pipette Tip	Blue	50 – 1000	✓	✓	✓	✓	✓	✓	✓	✓		

NB: Sterilin pipette tips are recommended for use with, but not limited to, the pipettors listed in this compatibility chart

## 16. Sterility, Aseptic Manufacture

The term 'aseptic' refers to methods and procedures designed to prevent the access of living or dead bacteria, fungi, viruses and other biological contamination, so that products or work areas are maintained in a biologically clean condition.

Petri dishes, containers and multiwell plates are examples of Sterilin products that are aseptically manufactured. During production, virgin polystyrene is subjected to temperatures in excess of 200°C and then injected into the mould at high pressure. These exacting conditions ensure a biologically clean product. Subsequent assembly and packaging is carried out by trained operators under cleanroom conditions (class 7, maintained as per BS EN ISO14644) to exclude any microbiological contamination. Stringent microbiological sampling of both the cleanroom environment and finished product ensures extremely clean product with a very high Sterility Assurance Level (SAL)



## 17. Sterility, Irradiation

Irradiation is a method of sterilisation which involves subjecting the finished product and its packaging to ionising radiation. The radiation breaks down DNA and so destroys living organisms.

Sterilin Ltd uses gamma irradiation for the sterilisation of products which are complex to manufacture under aseptic conditions. These include Sterilin pipettes and microtitration plates. Products that have been subjected to sterilisation via irradiation are usually denoted by a red indicator on the packaging.

## 18. Sterility, Sterility Assurance Level (SAL)

Sterility can be defined in terms of the "probability" of a micro-organism being present on the product.

For a medical device to be labelled "Sterile", the probability that a viable organism is present on the device must be less than or equal to  $1 \times 10^{-6}$  (1 colony per 1,000,000 product). This equates to a Sterility Assurance Level of 6.

For aseptically manufactured product the probability that a viable organism is present on the product is less than or equal to  $10^{-3}$  (1 colony per 1,000 product). This equates to a Sterility Assurance Level of 3.

## 19. Swabs, Applicator Type

(cat page 49)



Depending on the area of the body where the sample is taken, one applicator may be more relevant than others.

- Plastic shaft (polystyrene), inert non-toxic material. Most common choice
- Twisted wire shaft due to its flexibility is designed specifically for nasopharyngeal sampling
- Aluminium shaft is generally used for ear, nose, eye and male urethral sampling. It is also excellent for paediatric use

## 20. Swabs, Tip Material

- Viscose (Rayon) – a derivative of cellulose. As it is non-toxic to organisms, it is the most common type for microbiology
- Polyester (Dacron) – a synthetic fibre. Essential for use with PCR or similar DNA tests where the DNA of viscose could interfere with the results

## 21. Swabs, Transport Medium

- As there is often a delay between sampling and the subsequent analysis, medium is added to preserve (not inhibit or enhance) the micro-organism that may be present on the swab
- Due to the broad spectrum use of swabs and differing environmental requirements it is important that the transport medium is suitable for all microorganisms
- Amies is the most common medium and is ideal for general-purpose use
- The transport media can be in gel or liquid form

### a) Gel or Liquid

- Gel is generally the preferred option because it keeps air out of the medium and is less toxic to bacteria
- The main use of a liquid medium is for rapid tests - here the use of gel may not be appropriate, i.e. microscopic slides

### b) Charcoal or Without ?

- The property of charcoal is to absorb pollutants and other substances that could be toxic to bacteria. Advised for use with difficult bacteria, particularly *Neisseria gonorrhoea*

## 22. Swabs, Packaging

### a) Venturi Design

- Sterilin's Transport Swab has been carefully designed and engineered to provide superior swab performance
- A carefully engineered neck constriction and moulded fins creates a deliberate Venturi effect when the swab is introduced
- The Venturi action works to immediately surround and seal in the swab tip, eliminating any bubbles, cracks and breaks that would normally occur in the agar, protecting bacteria from the harmful effects of atmospheric oxygen



### b) Unique Swab Packaging System

- Sterilin's unique packaging for the Sterilin range of transport swabs combines an outer foil pack and an inner plastic pouch, both with a vacuum and nitrogen gassed assembly process
- The outer foil bag serves to reduce evaporation and dehydration of the media whilst also protecting the product from harmful effects of sunlight
- The inner plastic pouch has notable benefits over traditional porous paper-plastic film packaging;
  - Totally waterproof, protecting the product from accidental contamination
  - Prevents evaporation and dehydration, keeping the transport medium fresh until the moment the product is opened for maximum bacterial recovery
  - Airtight to prevent oxygen penetration and subsequent media oxidation
  - Simpler to recycle than traditional paper and plastic packaging and so more likely to be disposed of in the correct way



## 23. Swabs, M40

(cat page 51)

The culture swab is one of the most widely used devices for the transport and collection of patient specimens. The key to accurate diagnosis lies with the collection and maintenance of the initial patient sample where the organisms collected need to be kept alive until processed in the laboratory. To help improve overall patient care it was recognised that there should be a minimum acceptable performance for all swabs – as such, the M40 standard was formulated. The basic criteria of the standard are as follows:

- Must cover all extremes of the microbiology spectrum from aerobes to anaerobes and fastidious bacteria – all organisms under all conditions
- Compliant at room temperature (21°C) and + 4°C
- Length of time for bacterial survival – 48 hours
- Performance must be the same throughout the shelf life

**Sterilin M40 swabs comply with the new NCCLS M40-A and German DIN 58942-A performance standards**

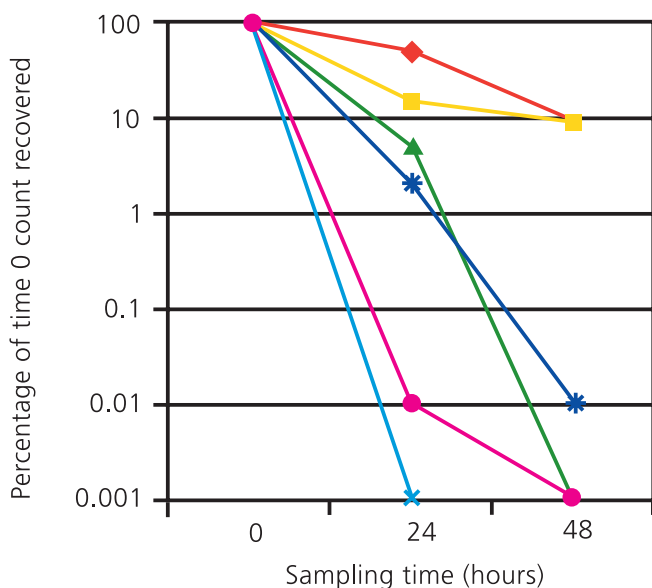

- ◆ Sterilin M40, amies
- ◆ Sterilin M40 + charcoal
- ▲ Competitor A + charcoal
- ✕ Competitor A, amies
- ✱ Competitor B + charcoal
- Competitor B, amies

Y axis 0 = none recovered;  
<2.2 cfu/ml in washings

## 24. Swabs, Swab Rinse Kits

(cat page 53)

### a) Method of Use

- Peel open the swab rinse kit pouch and remove the sampling swab
- Swab the test site. If the surface is dry pre-moisten the swab in the rinse solution provided. If a template is being used swab the designated area
- After sampling, break the swab applicator into the tube of rinse solution (if using the alginate swab the tip will dissolve)
- Transport back to the laboratory as soon as possible
- Plate the required dilution into the appropriate media, preferably within 4 hours of swabbing. Where this is not possible refrigerate at 4°C and analyse within 24 hours of swabbing
- To calculate the number of colony forming units per cm<sup>2</sup> (CFU/cm<sup>2</sup>) when using the 10 x 10cm template use the following; (number of colonies x volume of rinse solution x serial dilution)/100



### b) Swab Rinse Kit (SRK) Solution

Used in environmental monitoring situations, the SRK solution constituents are:

- Ringers balanced salt solution
- Tween 80
- Lecithin
- Sodium Thiosulphate
- Sodium Thioglycollate
- Sodium Disulphate
- Sodium Pyruvate
- Sodium Hexametaphosphate

## 25. Tubes, Dimensional Information

(cat page 55)

Dimensions provided in this table are given for guidance purposes only.

Sterilin Ltd reserves the right to make modifications without prior notice.

Product Code	Diameter at Base (mm)	Height incl Cap (mm)	Diameter over Thread (mm)	ID (mm)	OD at Top (mm)
505	14.5	58	N/A (internal cap)	12.5	15.0
S31	26.5	60	21.4	17.0	26.5
38091	27.0	60	21.6	16.0	27.0
142B	14.5	100 (no cap)	N/A	14.0	17.8
142AS	14.5	101.5	17.7	14.0	15.7
144B	14.5	109.5 (no cap)	N/A	14.0	17.8
144AS	14.5	114	17.7	14.0	15.7
36100	14.5	114	17.7	14.0	15.7
15PPR	15.5	120	19.0	15.5	17.5
15PSR	15.5	120	19.0	15.5	17.5
36050NPG	28.0	118	31.5	27.5	29.5



## 26. Tubes, Centrifuge

### RCF values and calculation

This catalogue lists a number of centrifuge tubes and other containers that are routinely used in centrifugation procedures. For reasons of safety, care must be taken not to exceed the maximum Relative Centrifugal Force (RCF) advised for the tube.

The following table and nomogram have been provided to give assistance in this respect.

Do note that the values are for tubes in good condition, used with balanced rotors, correct adaptors and the appropriate size buckets.

Product Code	Description	Capacity (ml)	Material	Maximum Recommended RCF x g
142B	Round base tube	13.5	PS	3200
142AS	Round base tube, screw cap	13.5	PS	3200
142ASR	Round base tube, wadded screw cap	13.5	PS	3200
144B	Conical base tube	13.5	PS	3200
144AS	Conical base tube, screw cap	13.5	PS	3200
36100	Conical base tube, wadded screw cap	13.5	PS	3200
15PPR	Centrifuge tube	15.0	PP	6300
15PPB	Centrifuge tube	15.0	PP	6300
15PSR	Centrifuge tube	15.0	PS	3800
15PSB	Centrifuge tube	15.0	PS	3800
36050NPG	Centrifuge tube	50.0	PP	7200
36050CPG	Centrifuge tube	50.0	PP	9200
112	Round base tube, 40x11mm	2.3	PS	4600
RT25	Round base tube, 65x10mm	2.7	PS	2600
RT30	Round base tube, 75x12mm	4.9	PS	5400
128	Universal container	30.0	PS	3800
129	Bijou	7.0	PS	7200

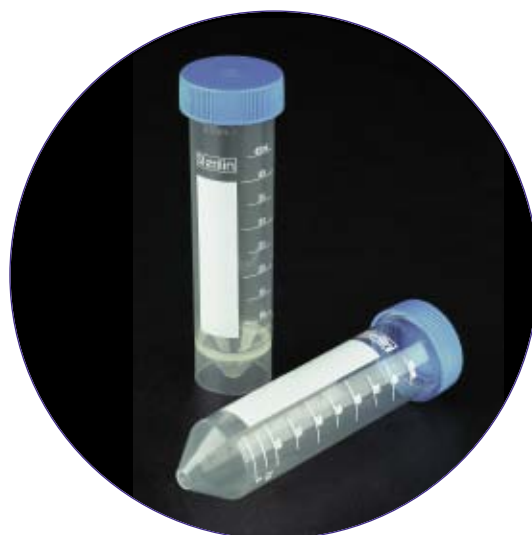

See opposite page for nomogram and working examples

### Speed - RCF - Nomograph

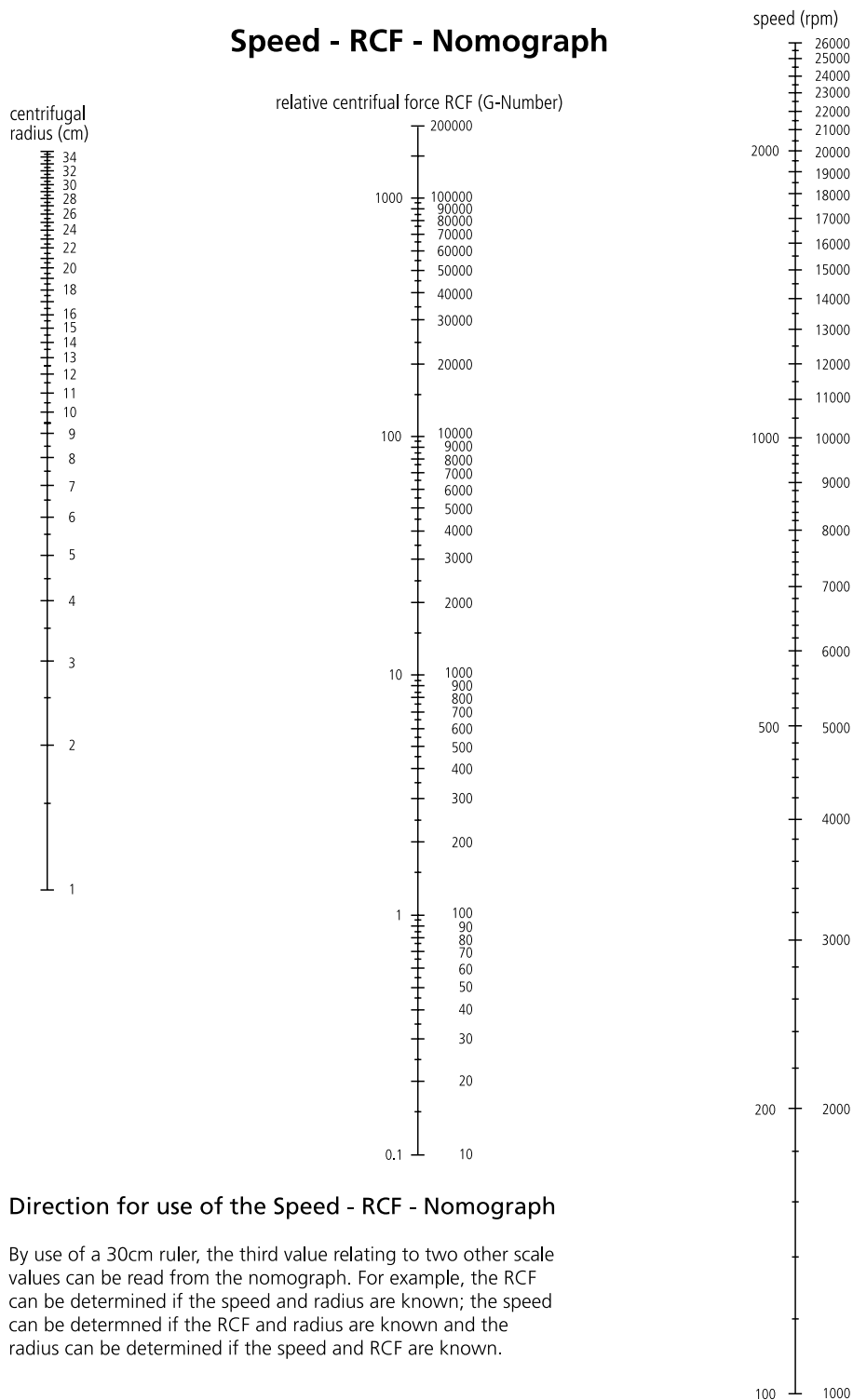

#### Direction for use of the Speed - RCF - Nomograph

By use of a 30cm ruler, the third value relating to two other scale values can be read from the nomograph. For example, the RCF can be determined if the speed and radius are known; the speed can be determined if the RCF and radius are known and the radius can be determined if the speed and RCF are known.

#### Example 1

If the centrifugal radius is 14 cm, and the relative centrifugal force is 10,000 x g, using a 30 cm ruler, the centrifuge speed is calculated as 8,000 rpm.

#### Example 2

If the centrifugal radius is 23 cm, the relative centrifugal force is 300 x g, using a 30 cm ruler, the centrifuge speed is calculated as 1,100 rpm.

# index (by catalogue number)

Catalogue Number	Page Number	Catalogue Number	Page Number	Catalogue Number	Page Number
<b>1</b>					
1000-035	72	129A	10	192BLUE	24
1000PPN	19	129AX/1	10	193A	18
1000PETGN	8	129B	10	194IW	24
1000PETGNTN	8	129BBAC	10	194IWBLUE	24
1001PPN	19	129BX/1	10	195PPD	24
1002PPI	19	129PYR	14	1CRES	58
100CTP	64	142AS	61	1CRIS	58
100CTP1	64	142ASR	61		
100CTS	64	142B	61	<b>2</b>	
100CTS1	64	144AS	61	200C	44
100FLMS	18	144B	61	200PPD	24
100FLPLS	18	144C	52	200PPN	19
100FLS	18	145C	52	2012-003	74
101/IRR	32	147A	61	201C	44
1010-060	72	147C	52	201PPN	19
101R20	32	148C	52	202C	44
101RT	32	15PPB	62	202PPI	19
101RT/IRR	32	15PPR	62	2032-013	74
101V/IRR	32	15PSB	62	2052-025	74
101VAMB	33	15PSR	62	2053-025	74
101VBLUE	33	164K501	53	2055-033	74
101VR05TB	33	165A	13	205PPD	24
101VR18TB	33	165B	13	210PPD	24
101VR20	32	165C	13	2132-050	74
101VRED	33	165KS01	53	2150N	61
1020-100	72	165KS100	53	2150R	61
103	34	165PYR	14	215PPD	24
1030-150	72	170C	52	220R	22
109	34	1803-096	73	221M	22
1100-025	76	1804-096	73	221S	22
1110-075	76	18108CST	50	222M	22
112	62	18110CST	50	222S	22
1160-225	76	18111CST	50	2322-015	82
121V	32	18114CST	50	2323-015	82
122	32	18116CST	50	2324-015	82
123	32	18190CST	50	2325-015	82
124	32	18192CST	50	2342-050	82
125AM	12	1820-024	79	2343-050	82
125AP	12	1830-048	79	2344-050	82
125BM	12	185AM	13	2345-050	82
125BP	12	185AP	13	250PETN	8
125CM	12	185BM	13	250PETNTN	8
125CP	12	185BP	13	28308	26
125PYR	14	185CM	13	28316	26
128A	11	185CP	13	28324	26
128B	11	185DB/IRR	15	28332	26
128BBAC	11	185PYR	14	28340	26
128C	11	190A	13	28357	26
128DB/IRR	15	190B	13	28365	26
128PYR	14	190C	13	28373	26
128SA	12	190DB/IRR	15	28381	26
128SB	12	190PYR	14	28399	26
128SBB	12	191	24	28407	26
128SC	12	191BLUE	24	28415	26
		192	24	28423	26



Catalogue Number	Page Number	Catalogue Number	Page Number	Catalogue Number	Page Number
28431	26	3103-025	76	40102K	39
28449	26	3110-075	75	40102NPK	39
28456	26	3113-025	76	40105	39
28464	26	3120-150	75	40105NP	39
28472	26	3123-075	76	40125	39
28480	26	3133-150	76	40125NP	39
28498	26	3143-225	76	401PPN	19
2CRER	56	3160-225	75	4020-010	80
2CRES	56	328C	55	4020-020	81
2CRIR	58	330C	55	4020-030	80
2CRIS	58	346C	55	4020-040	81
		347C	55	402PPI	19
<b>3</b>		350C	55	4030-010	80
3000-035	72	35002S	59	40301K	39
300FLS	18	3520CA	54	40302K	39
300FLPLS	8	3520CF	54	40305	39
3010-60	72	3520CS01	54	40501K	40
3020-100	72	359C	55	40502K	40
30205	68	360C	55	408CST	51
30206	69	361C	55	4100-010	80
30254	68	36050CPG	62	4100-020	81
30255	69	36050NPG	62	4110-010	80
3030-150	72	36100	61	41301K	41
30304	68	3801-096	73	41302K	41
30305	69	3802-096	73	41305	41
30311	68	38091	60	41310	41
30312	68	3810-006	78	414CST	51
30314	68	3815-012	78	4160-10	80
30315	68	3820-024	78	40023	91
30317	68	3830-048	78	42505	41
30318	68	3860-096	78	42510	41
30321	69	3861-096	78	43301PK	41
30322	70	3870-096	78	43302PK	41
30324	69	3875-096	79	451CST	52
30325	70	3881-096	73	47105	39
30327	69	3882-096	73	47105N	40
30328	70	3883-096	73	47110	39
30331	69	3900-035	77	47110N	40
30332	70	3901-035	77	47150	39
30334	69	3930-035	77	47305	39
30335	70	3931-035	77	47305N	40
30337	69	39503T	20	47310	39
30338	70	3CRES	58	47310N	40
30353	70			47505	40
30403	70	<b>4</b>		47510	40
30452	70	4000-010	80	47525	40
305C	55	4000-020	81	47550	40
30502	70	4000-030	80	480CE	56
30890	64	4000-040	81	481CE	56
30908	64	400PPN	19	4810-010	80
30924	64	4010-010	80	4810-020	81
30932	64	4010-020	81	4815-010	80
30981	64	4010-030	80	4815-020	81
3100-025	75	4010-040	81	4816-010	80
3102-025	75	40101K	39	4816-060	81
		40101NPK	39		

# index (by catalogue number)

Catalogue Number	Page Number	Catalogue Number	Page Number	Catalogue Number	Page Number
482CE	56	5712-002	72	<b>9</b>	
4820-020	81	5722-004	72	9000-220	79
4822-010	80	5732-008	72	9010-320	79
4826-010	80	5816-006	78	902C	53
4826-060	81	5826-024	78	903C	53
483CE	56	5866-096	78	904C	53
4826-010	80	5882-096	77	905C	53
484CE	56	5883-384	77	922C	53
4860-010	80	5CRES	58	926C	53
4860-020	81	5CRIR	58	9330-050	63
4866-010	80			99445-10	65
4866-060	81	<b>6</b>		99445-12	65
49635	63	60FLPLS	18	99445-13	65
49684	63	60FLPMS	18	99445-15	65
4CRES	56	60FLS	18	99445-16	65
4CRIR	56	611F96	30	99445-16X	65
4CRIS	56	611F96BK	30	99445-16XX	65
		611F96WT	30	99445-18	65
		611U96	30	99445-20	65
		611V96	30	99448-16	66
		612F96	30	99448-19	66
		612U96	30	99449-13	65
		612V96	30	99449-16	65
		642000	30	99449-16X	65
				99449-16XX	65
<b>5</b>		<b>7</b>		99449-20	65
500PETG	8	7077-10N	42	99449-20X	65
500PETGNT	8	7077-1N	42	9998-13	66
500WSC	8	7077-2N	42	9998-15	66
500WSCNT	8	7077-5N	42	9998-18	66
501CS01	54	7078-10N	42	99999-13	66
501V	34	7078-1CN	42	99999-15	66
501VTB	33	7078-1N	42	99999-18	66
502CS01	54	7078-2N	42		
502VF	33	7078-5N	42	<b>B</b>	
503CS01	54	7078-5X	42	BCB25	46
503VF	33	7078B-1	43	BCB30	46
504	35	7078B-10	43	BCB70	47
505	60	7078B-25	43	BCR10	47
509	2	7078B-5	43	BCR20	47
509HT	2	7078B-50	43	BCT10	46
509L	2	7079-10N	43	BCT100	48
509LHT	2	7079-1N	43	BCT110	48
510	2	7079-2N	43	BCT20	46
510HT	2	7079-5N	43	BCT25	46
510LS	2	7079-5X	43	BCT30	46
511CS01	54	75CTP	64	BCT40	46
510LHT	2	75CTP1	64	BCT50	47
511HT	2	75CTS	64	BCT60	47
511	2	75CTS1	64	BCT70	47
516C	54			BCT70S	47
516CS01	54			BCT80	47
52FLMS	18			BCT90	47
52FLPLS	18			BCTR10	46
52FLS	18			BCTR20	46
551C	54				
552C	54				
553C	54				
5702-001	72				

Catalogue Number	Page Number	Catalogue Number	Page Number	Catalogue Number	Page Number
BCTR25	46	<b>M</b>		<b>W</b>	
BCTR30	46	MP52	14	WKS1	59
BCTR60	47	MPE0712	3	<b>Z</b>	
BCTR70	47	MPE0717	3	Z10PE	63
BG50	6	MPE1730	3	Z10PENL	63
BG50E	6	MPE2530	3	Z10PS	63
BG60	6	<b>N</b>		Z10PSNL	63
BG60E	6	NA2	63	Z5PE	63
BG92	6	NA2L	63	Z5PENL	63
<b>C</b>		<b>P</b>		Z5PS	63
C2A	64	PF55	32	Z5PSNL	63
CRBOX1	60	PF55V	32		
CRBOX2	60	PP88SA	44		
CRBOX3	60	PP88SB	44		
CRBOX4	60	PP89SA	44		
CRINM	59	PP89SB	44		
<b>G</b>		<b>Q</b>			
G-PLATE	36	QL1	28		
<b>L</b>		QL10	28		
LXP125	17	<b>R</b>			
LXP125B	17	RT15	64		
LXP125L	17	RT20	64		
LXP125LB	17	RT25	64		
LXP125R	17	RT30	64		
LXP180	17	<b>S</b>			
LXP180L	17	S23B	2		
LXP180LB	17	S23C	2		
LXP180LR	17	S23E	2		
LXP180R	17	S28	42		
LXP30L	17	S28BL	42		
LXP30LB	17	S31	60		
LXP40	17	S400	4		
LXP40L	17	S405	4		
LXP40LB	17	S408	4		
LXP60	17	S435	4		
LXP60L	17	SL10H	28		
LXP60LR	17	SL10S	28		
LXP60R	17	SL1H	28		
LXPB125L	17	SL1S	28		
LXPB180	17	SN20	28		
LXPB180L	17	SPCS01	28		
LXPB40	17	SPCS05	28		
LXPB60	17	<b>U</b>			
LXPB60L	17	UC/30	20		
LXPR125	17	<b>V</b>			
LXPR180L	17	VIT-C001	82		
LXPR60L	17				

# index (alphabetical)

Item	Page Number	Item	Page Number	Item	Page Number
<b>A</b>					
Absorbent Paper - BenchGuard	6	- Polypropylene, Hinged Lid	18	Glass Containers	20
Assay Plates	30, 73	- Polypropylene, Snap Cap	19	Glass Pipettes	42-43
Autoclave Bags	2	- Polystyrene	10-15	Glass Tubes	63-64
Autoclave Bag Holders	2-3	-Screw Cap Jar	26	<b>H</b>	
Autoclave Basket	84	- Universal, Glass	20	Homogeniser Bags	4
<b>B</b>					
Bags		- Universal, Polystyrene	11	<b>I</b>	
- Autoclave	2	Cryogenic Vials	58-59	Inoculating Loops	28
- Biohazard	2	Cryogenic Vial Storage Box	60	Inoculating Needles	28
-Homogeniser	4	Cryogenic Vial Workstation	59	<b>J</b>	
- Metal Closure	3	Culture Tubes		Jars, Screw Cap	26
- Sampling	3	- Glass Disposable	65-66	<b>L</b>	
BenchGuard – Absorbent Paper	6	- Glass Reusable	91	Loops	28
Beakers, Weighing	70	- Plastic Disposable	64	<b>M</b>	
Bijou Container, Glass	20	Cuvettes	22	Membrane Filters	74
Bijou Container, Polystyrene	10	Cuvette Rack	22	Metal Closure Bags	3
Blood Tube Rotator	92	<b>D</b>			
Boats, Weighing	68-70	Dippers	24	Microcentrifuge Tubes	59
Boric Acid Container	10, 11	Discs, Silicone Rubber	87	Microtitration Plates	30
Bottles, Water Sampling	8	Dishes		Milk Pipettes	41
Box, Pipette Tips	48	- Glass Based	77	Multiwell Plates	
<b>C</b>					
Cell Biology		- Substrate Coated	80-81	- Assay	30, 73
- Chamber Slides	72	- Petri	32-36	- Elisa	73
- Dishes	72	- TC Treated	72	- Glass Based	77-78
- Elisa/Assay Plates	73	- TC Untreated	72	- Substrate Coated	80-81
- Filters, Membrane	74	Dish Scraper	79	- TC Treated	78
- Flasks	75-76	Double Bagged Containers	15	- TC Untreated	79
- Glass Based Dishes	77	<b>E</b>			
- Glass Based Plates	77-78	e-swab	56	Needles	28
- Multiwell Plates	78-79	Elisa Plates	73	Non-Pyrogenic Containers	14
- Pipettes	38-43	Environmental Swabs	53	<b>P</b>	
- Scrapers	79	Erlenmeyer Flasks, Glass	91	Petri Dishes	
- Substrate Coated Products	80-82	ESR Pipettes	42	- Coloured	33
- Tubes	60, 62-64, 82	<b>F</b>			
Cell Scraper	79	Fibronectin Coated Ware	80	- Compartmented	33
Centrifuge Tubes	61-63	Filter, Membrane	74	- Contact Plate	35
Chamber Slides	72	Flasks		- Square	34
Coated Tissue Culture Ware	80-82	- Erlenmeyer, Glass	91	- Standard	32
Collagen 1, Coated Ware	80-82	- Substrate Coated	80-81	- TC Treated	72
Coloured Petri Dishes	33	- TC Treated	75-76	- Training Aids	36
Compartmented Petri Dishes	33	- TC Untreated	76	- Triple Bagged	33
Contact Plate	35	- Vented	76	Pipette Tips	46-48
Containers		- Non-Vented	75-76	Pipette Tip Boxes	48
- 24 Hour Urine	19	Flask Scraper	79	Pipettes	
- Bijou, Glass	20	Flocked Swabs	54	- ESR	42
- Bijou, Polystyrene	10	<b>G</b>			
- Double Bagged	15	Gelatin Coated Ware	81	- Glass	42-43
- Glass Disposable	20	Glass Based Dishes	77	- Milk	41
- Mucus Extractor	14	Glass Based Plates		- Narrow Orifice	40
- Non-Pyrogenic	14	- Culture	78	- Open Ended	41
- Polypropylene, Screw Cap	16-18	- Assay	77	- Plastic Transfer	44
		- Substrate Coated	80-81		



Item	Page Number	Item	Page Number	Item	Page Number
- Polystyrene	38-42				
- Serological	38-42				
- Shortie	41				
- Unplugged	39				
Plain Swabs	52				
<b>R</b>					
Rack, Cuvette	22				
Rack, Microcentrifuge Tube	59				
<b>S</b>					
Sample Transport	65-66				
Sampling					
- Bags	3				
- Utensil	4				
Scintillation Vials	60				
Scrapers	79				
Serological Pipettes	38-43				
Shortie Pipettes	41				
Spreaders	28				
Square Petri Dishes	34				
Straws, Sampling	4				
Substrate Coated Ware	80-81				
Swabs					
- e-swab	56				
- Environmental/Rinse Kits	53				
- Flocked	54				
- M40	51				
- Plain	52				
- Transport	50-51				
- Viral	52				
- Universal Transport Medium	55				
<b>T</b>					
Technical Information	97-109				
Trac Bottle	10				
Transport Packaging System	65-66				
Transport Swabs	50-51				
Tubes					
- Centrifuge	61-63				
- Culture Plastic	64				
- Culture Glass	65-66				
- Glass Reusable	91				
- Plastic Disposable	61-64				
<b>U</b>					
Universal Containers, Glass	20				
Universal Containers, Polystyrene	11				
U.N. Packaging System	65-66				
Universal Transport Medium	55				
<b>V</b>					
Vials					
- Cryogenic	58-59				
- Scintillation	60				
Viral Transport Swabs	52				
<b>W</b>					
Water Sampling Bottles	8				
Weighing Beakers	70				
Weighing Boats	68-70				

# Sterilin®

I.C.T, S.L. Avda. de Juan Carlos I, 24  
Spain Tel: +34 902 193 170 · Fax: +34 902 193 167  
commercial@ictsl.net · www.ictsl.net

